

Hydraulic Hose, Fittings and Accessories



Stirling Hydraulic

TABLE OF CONTENTS

Hydraulic Hose	Single Wire Braid _____	3
	Double Wire Braid _____	3-4
	Four Spiral _____	5
	Six Spiral _____	6
	Jack Hose _____	6
	Truck Hose _____	7
	Suction & Push-On _____	8
	Thermoplastic _____	9-10
	BOP Hose _____	11
	Oilfield 2" Kelly _____	11
	Grease Hose _____	11
	Pressure Washer _____	12
	Teflon _____	12
	Crimp Fittings	Crimp Fitting Compatability Chart _____
Pipe Thread _____		14
JIC 37° Flare _____		15-16
SAE Flareless _____		16
SAE 45° _____		16
O-Ring Boss _____		16
O-Ring Face Seal _____		16-17
Inverted Flare _____		17-18
C61 Flange _____		18
C62 Flange _____		19
Cat Flange _____		19
Komatsu _____		20
BSP _____		20-21
Metric _____		21-23
Reusable Hose Fittings	Steel _____	24
	Brass _____	25
Adapters	Thread Chart _____	26
	Pipe Thread _____	27-36
	JIC 37° Flare _____	37-53
	O-Ring Boss _____	54-62
	O-Ring Face Seal _____	63-71
	BSP _____	72-74
Metric _____	75-76	
Live Swivel Joints	Straight Swivel Joints _____	77
	90° Swivel Joints _____	77-78
SAE Flange	Steel Flange C61 _____	79
	Steel Flange C62 _____	80
	Black Pipe Flange C61 _____	81
O-Rings	O-Rings _____	81

THREAD DIMENSIONS

PIPE THREAD

Dash Size	Pipe Size	Pitch (Threads/Inch)	Male Thread O.D.	Female Thread O.D.
02	1/8	27	0.41	0.37
04	1/4	18	0.54	0.49
06	3/8	18	0.68	0.62
08	1/2	14	0.84	0.76
12	3/4	14	1.06	0.98
16	1	11-1/2	1.31	1.24
20	1-1/4	11-1/2	1.66	1.58
24	1-1/2	11-1/2	1.90	1.82
32	2	11-1/2	2.38	2.28

O-RING FACE SEAL

Dash Size	Male Thread O.D.	Pitch (Threads/Inch)
04	9/16"	18
06	11/16"	16
08	13/16"	16
10	1"	14
12	1-3/16"	12
16	1-7/16"	12
20	1-11/16"	12
24	2"	12

JIC THREAD

Dash Size	Male Thread O.D.	Pitch (Threads/Inch)
02	5/16"	24
03	3/8"	24
04	7/16"	20
05	1/2"	20
06	9/16"	18
08	3/4"	16
10	7/8"	14
12	1-1/16"	12
14	1-3/16"	12
16	1-5/16"	12
20	1-5/8"	12
24	1-7/8"	12
32	2-1/2"	12

ORB THREAD

Dash Size	Male Thread O.D.	Pitch (Threads/Inch)
02	5/16"	24
03	3/8"	24
04	7/16"	20
05	1/2"	20
06	9/16"	18
08	3/4"	16
10	7/8"	14
12	1-1/16"	12
14	1-3/16"	12
16	1-5/16"	12
20	1-5/8"	12
24	1-7/8"	12
32	2-1/2"	12

INVERTED FLARE

Dash Size	Male Thread O.D.	Pitch (Threads/Inch)
02	5/16"	28
03	3/8"	24
04	7/16"	24
05	1/2"	20
06	5/8"	18
07	11/16"	18
08	3/4"	18
10	7/8"	18
12	1-1/16"	16

SAE 45° THREAD

Dash Size	Male Thread O.D.	Pitch (Threads/Inch)
02	5/16"	24
03	3/8"	24
04	7/16"	20
05	1/2"	20
06	5/8"	18
08	3/4"	16
10	7/8"	14
12	1-1/16"	14
14	1-1/4"	12
16	1-3/8"	12

METRIC THREAD LIGHT

DASH SIZE	TUBE O.D.	METRIC THREAD
06	06 mm	12 mm x 1.5
08	08 mm	14 mm x 1.5
10	10 mm	16 mm x 1.5
12	12 mm	18 mm x 1.5
15	15 mm	22 mm x 1.5
18	18 mm	26 mm x 1.5
22	22 mm	30 mm x 2.0
28	28 mm	36 mm x 2.0
35	35 mm	45 mm x 2.0
42	42 mm	52 mm x 2.0

METRIC THREAD HEAVY

DASH SIZE	TUBE O.D.	METRIC THREAD
06	06 mm	14 mm x 1.5
08	08 mm	16 mm x 1.5
10	10 mm	18 mm x 1.5
12	12 mm	20 mm x 1.5
14	14 mm	22 mm x 1.5
16	16 mm	24 mm x 1.5
20	20 mm	30 mm x 2.0
25	25 mm	36 mm x 2.0
30	30 mm	42 mm x 2.0
38	38 mm	52 mm x 2.0

BSPP THREAD

Dash Size	Pipe Size	Threads per inch	Pitch in.	Pitch mm	Outer Dia. in.	Outer Dia. mm
02	1/8	28	0.0357	0.907	0.3830	9.728
04	1/4	19	0.0526	1.337	0.5180	13.157
06	3/8	19	0.0526	1.337	0.6560	16.662
08	1/2	14	0.0714	1.814	0.8250	20.955
10	5/8	14	0.0714	1.814	0.9020	22.911
12	3/4	14	0.0714	1.814	1.0410	26.441
16	1	11	0.0909	2.309	1.3090	33.249
20	1-1/4	11	0.0909	2.309	1.6500	41.910
24	1-1/2	11	0.0909	2.309	1.8820	47.803
32	2	11	0.0909	2.309	2.3470	59.614

SINGLE WIRE BRAID

S311 SAE 100R1AT EN853 - 1 SN

APPLICATION Petroleum based hydraulic fluids, gasoline, water, diesel fuels and lubricating oils.
TUBE Black, oil and heat resistant synthetic rubber.
REINFORCEMENT One braid of high tensile steel wire.
COVER Black, oil, abrasion and weather resistant synthetic rubber. MSHA approved flame retardant.
TEMPERATURE (-40°C to +100°C), (-40°F to +212°F) continuous, *intermittent +125°C (+257°F)

Part No.	I.D. in	I.D. mm	O.D. in	O.D. mm	Max. W.P. psi	Min. Burst psi	Min. Bend Radius (in)	Min. Bend Radius (mm)	Weight lbs./ft.	Coupling Series
S311-04	1/4	6.4	0.52	13.2	3263	13052	4	102	0.15	K
S311-06	3/8	9.5	0.68	17.2	2610	10440	5	127	0.22	K
S311-08	1/2	12.7	0.81	20.4	2320	9280	7	178	0.28	K,J
S311-10	5/8	16	0.94	23.5	1885	7540	8	203	0.32	K,J
S311-12	3/4	19	1.09	27.5	1523	6092	9.5	241	0.44	K,J
S311-16	1	25.4	1.40	35.4	1276	5104	12	305	0.70	K,J
S311-20	1-1/4	31.8	1.70	43.5	914	3656	16.5	419	0.80	J
S311-24	1-1/2	38.1	1.97	50.0	725	2900	20	508	1.08	J
S311-32	2	50.8	2.50	63.6	580	2320	25	635	1.38	J

DOUBLE WIRE BRAID

S421 - SAE 100R2AT - EN853 - 2SN

APPLICATION Petroleum based hydraulic fluids, gasoline, water, diesel fuels and lubricating oils.
TUBE Black, oil and heat resistant synthetic rubber.
REINFORCEMENT Two braids of high tensile steel wire.
COVER Black, oil, abrasion and weather resistant synthetic rubber, MSHA approved flame retardant.
TEMPERATURE (-40°C to +100°C), (-40°F to +212°F) c ontinuous, *intermittent +125°C (+257°F)

Part No.	I.D. in	I.D. mm	O.D. in	O.D. mm	Max. W.P. psi	Min. Burst psi	Min. Bend Radius (in)	Min. Bend Radius (mm)	Weight lbs./ft.	Coupling Series
S421-04	1/4	6.4	0.59	15.0	5800	23200	4.0	102	0.24	K
S421-06	3/8	9.5	0.75	19.1	4785	19140	5.0	127	0.34	K
S421-08	1/2	12.7	0.87	22.1	3988	15952	7.0	178	0.42	K,J
S421-10	5/8	16	1.00	25.4	3625	14500	8.0	203	0.51	K,J
S421-12	3/4	19	1.15	29.2	3118	12472	9.5	241	0.65	K,J
S421-16	1	25.4	1.50	38.1	2393	9572	12.0	305	0.98	K,J
S421-20	1-1/4	31.8	1.90	48.3	1813	7252	16.5	419	1.26	J
S421-24	1-1/2	38.1	2.14	54.4	1305	5220	20.0	508	1.45	J
S421-32	2	50.8	2.65	67.3	1131	4524	25.0	635	1.99	J

CONSTANT PRESSURE 3000 PSI

S470 SAE 100R17 - CONSTANT 3045 PSI

APPLICATION Petroleum based hydraulic fluids, gasoline, water, diesel fuels and lubricating oils.
 TUBE Black, oil and heat resistant synthetic rubber.
 REINFORCEMENT One (up to 1/2") or two (from 5/8") braids of high tensile steel wire.
 COVER Black, oil, abrasion and weather resistant synthetic rubber, MSHA approved.
 TEMPERATURE (-40°C to +100°C), (-40°F to +212°F) c ontinuous, *intermittent +125°C (+257°F)

Part No.	I.D. in	I.D. mm	O.D. in	O.D. mm	Max. W.P. psi	Min. Burst psi	Min. Bend Radius (in)	Min. Bend Radius (mm)	Weight lbs./ft.	Coupling Series
S470-04	1/4	6.4	0.48	12.2	3045	12180	2	51	0.12	K
S470-06	3/8	9.5	0.61	15.5	3045	12180	2.5	64	0.14	K
S470-08	1/2	12.7	0.75	19.1	3045	12180	3.5	89	0.28	K
S470-10	5/8	15.9	0.94	23.9	3045	12180	4	102	0.36	K
S470-12	3/4	19.0	1.10	27.9	3045	12180	4.7	119	0.52	K,J
S470-16	1	25.4	1.41	35.8	3045	12180	5.9	150	0.84	K,J

ULTIMATE TWO WIRE HOSE

S490 - ULTIMATE TWO WIRE

Compact design offering excellent flexibility and performance.
 TUBE Oil resistant nitrile rubber. ***SUPERIOR FLEXIBILITY**
 REINFORCEMENT Two braids of high tensile steel wire.
 COVER Oil, weather and abrasion resistant rubber, MSHA approved. ***HIGH PRESSURE PERFORMANCE**
 BENEFITS Lifetime Impulse resistance one million cycles.
 Meets or exceeds both SAE and DIN Specifications. ***COMPACT DESIGN**
 High performance, increased life and reliability.
 TEMPERATURE (-40°C to 121°C) (-40°F to 212°F) *inte rmittent 125°C (257°F)

Part No.	I.D. in	I.D. mm	O.D. in	O.D. mm	Max. W.P. psi	Min. Burst psi	Min. Bend Radius (in)	Min. Bend Radius (mm)	Weight lbs/ft	Coupling Series
S490-04	1/4	6.4	0.53	13.5	6,500	26000	1.79	45	0.19	K
S490-06	3/8	9.5	0.68	17.3	5,600	22400	2.8	71	0.29	K,J
S490-08	1/2	12.7	0.80	20.3	5,000	20000	3.53	90	0.36	K,J
S490-10	5/8	15.9	0.93	23.7	4,205	16820	5.1	130	0.44	K,J
S490-12	3/4	19.0	1.09	27.7	4,000	16000	6.3	160	0.55	K,J
S490-16	1	25.4	1.39	35.3	3,000	12000	8.3	211	0.75	K,J



FOUR SPIRAL HYDRAULIC HOSE

S900 SAE 100R12

APPLICATION	Hydraulic systems with petroleum or water/glycol based fluids and for fuel and lubricating oils.
TUBE	Oil resistant special synthetic rubber.
REINFORCEMENT	Four spirals of high tensile wire.
COVER	Black or Grey oil, abrasion and weather resistant synthetic rubber, MSHA approved.
TEMPERATURE	-40°C to 120°C (-40°F to 248°F)

Part No.	I.D. in	I.D. mm	O.D. in	O.D. mm	Max. W.P. psi	Min. Burst psi	Min. Bend Radius (in)	Min. Bend Radius (mm)	Weight lbs./ft.	Coupling Series
S900-06	3/8	9.5	0.80	20.3	4000	16000	5	127	0.42	J
S900-08	1/2	12.7	0.93	23.6	4000	16000	7	178	0.57	J
S900-10	5/8	15.9	0.97	24.6	4000	16000	8	203	0.74	J
S900-12	3/4	19.0	1.21	30.7	4000	16000	9.5	241	0.84	J
S900-16	1	25.4	1.50	38.1	4000	16000	12	305	1.24	J
S900-20	1-1/4	31.8	1.85	47.0	3000	12000	16.5	419	1.78	J
S900-24	1-1/2	38.1	2.1	53.3	2500	10000	20	508	2.15	J
S900-32	2	50.8	2.62	66.5	2500	10000	25	635	2.90	J

FOUR SPIRAL HYDRAULIC HOSE

***SUPERIOR FLEXIBILITY**
***HIGH PRESSURE PERFORMANCE**

S920 4SH * Exceeds requirements of EN856

APPLICATION	Hydraulic systems with petroleum or water/glycol based fluids and for fuel and lubricating oils.
TUBE	Oil resistant special synthetic rubber.
REINFORCEMENT	Four spirals of high tensile wire.
COVER	Oil, abrasion and weather resistant synthetic rubber, MSHA approved.
TEMPERATURE	-40°C to 100°C (-40°F to 212°F)

Part No.	I.D. in	I.D. mm	O.D. in	O.D. mm	Max. W.P. psi	Min. Burst psi	Min. Bend Radius (in)	Min. Bend Radius (mm)	Weight lbs./ft.	Coupling Series
S920-12	3/4	19.0	1.26	32.0	6090	24360	11	279	0.89	J
S920-16	1	25.4	1.50	38.1	5510	22040	13.4	340	1.30	J
S920-20	1-1/4	31.7	1.77	45.0	5075	20300	18.1	460	1.67	J
S920-24	1-1/2	38.1	2.08	52.8	4205	16820	22	559	2.05	J
S920-32	2	50.8	2.67	67.8	3625	14500	27.5	699	2.75	J

5000 PSI SPIRAL HYDRAULIC HOSE

S970 SAE 100R13

APPLICATION Hydraulic systems with petroleum or water/glycol based fluids and for fuel and lubricating oils.
TUBE Oil resistant special synthetic rubber.
REINFORCEMENT Four or Six spirals of high tensile wire. ***3/4" & 1" 4 Spiral *1-1/4" thru 2" 6 Spiral**
COVER Oil, abrasion and weather resistant synthetic rubber, MSHA approved.
TEMPERATURE (-40°C to + 120°C) (-40°F to +248°F)

Part No.	I.D. in	I.D. mm	O.D. in	O.D. mm	Max. W.P. psi	Min. Burst psi	Min. Bend Radius (in)	Min. Bend Radius (mm)	Weight lbs./ft.	Coupling Series
S970-12	3/4	19.0	1.26	32.0	5000	20 000	9.5	241	1.10	J
S970-16	1	25.4	1.52	38.6	5000	20 000	12	305	1.40	J
S970-20	1-1/4	31.8	1.96	49.8	5000	20 000	16.5	419	2.42	J
S970-24	1-1/2	38.1	2.26	57.4	5000	20 000	20	508	3.19	J
S970-32	2	50.8	2.79	70.9	5000	20 000	25	635	4.64	J

6090 PSI SPIRAL HYDRAULIC HOSE

S990 SAE 100R15

APPLICATION Hydraulic systems with petroleum or water/glycol based fluids and for fuel and lubricating oils.
TUBE Oil resistant special synthetic rubber.
REINFORCEMENT 4 or 6 spirals of high tensile wire. ***6 spiral above 1"**
COVER Oil, abrasion and weather resistant synthetic rubber, MSHA approved.
TEMPERATURE (-40°C to + 120°C) (-40°F to +248°F)

Part No.	I.D. in	I.D. mm	O.D. in	O.D. mm	Max. W.P. psi	Min. Burst psi	Min. Bend Radius (in)	Min. Bend Radius (mm)	Weight lbs./ft.	Coupling Series
S990-12	3/4	19.0	1.22	31.0	6090	24360	10.4	264	1.10	X
S990-16	1	25.4	1.54	39.1	6090	24360	13.0	330	1.45	X
S990-20	1-1/4	31.8	1.98	50.3	6090	24360	17.5	445	2.40	X
S990-24	1-1/2	38.1	2.28	57.9	6090	24360	20.9	531	3.00	X

TRUCK HYDRAULIC HOSE

S200 SAE 100R5

APPLICATION	Petroleum based hydraulic fluids, gasoline, water, diesel fuels and lubricating oils.
TUBE	Black, oil and heat resistant synthetic rubber.
REINFORCEMENT	One wire braid, two cotton braids.
COVER	Textile outer braid and a cotton braided black cover.
Color	Black
TEMPERATURE	(-40°C to + 121°C) (-40°F to +250°F)

Part No.	I.D. in	I.D. mm	O.D. in	O.D. mm	Max. W.P. psi	Min. Burst psi	Min. Bend Radius (in)	Min. Bend Radius (mm)	Weight lbs./ft.	Coupling Series
S200-04	3/16	4.8	0.52	13.2	3000	12000	3.0	76	0.14	BN
S200-05	1/4	6.4	0.58	14.7	3000	12000	3.4	86	0.18	BN
S200-06	5/16	7.9	0.68	17.3	2250	9000	4.0	102	0.23	BN
S200-08	13/32	10.3	0.77	19.6	2000	8000	4.6	117	0.26	BN
S200-10	1/2	12.7	0.92	23.4	1750	7000	5.5	140	0.36	BN
S200-12	5/8	15.9	1.08	27.4	1500	6000	6.5	165	0.44	BN
S200-16	7/8	22.2	1.23	31.2	800	3200	7.4	188	0.46	BN
S200-20	1-1/8	28.6	1.50	38.1	625	2500	9.0	229	0.53	BN
S200-24	1-3/8	34.9	1.75	44.5	500	2000	10.5	267	0.62	BN
S200-32	1-13/16	46.0	2.22	56.4	350	1400	13.3	338	0.84	BN

TRUCK HYDRAULIC HOSE

S210 SAE 100R5 HIGH TEMPERATURE

APPLICATION	Petroleum based hydraulic fluids, gasoline, water, diesel fuels and lubricating oils.
TUBE	Black, oil and heat resistant synthetic rubber.
REINFORCEMENT	One wire braid, two cotton braid.
COVER	Textile outer braid and a cotton braided blue cover.
COLOR	Blue
TEMPERATURE	(-55°C to + 150°C) (-49°F to +300°F)

Part No.	I.D. in	I.D. mm	O.D. in	O.D. mm	Max. W.P. psi	Min. Burst psi	Min. Bend Radius (in)	Min. Bend Radius (mm)	Weight lbs./ft.	Coupling Series
S210-04	3/16	4.8	0.52	13.2	3000	12000	3.0	76	0.13	BN
S210-05	1/4	6.4	0.58	14.7	3000	12000	3.4	86	0.16	BN
S210-06	5/16	7.9	0.68	17.3	2250	9000	4.0	102	0.23	BN
S210-08	13/32	10.3	0.77	19.6	2000	8000	4.6	117	0.26	BN
S210-10	1/2	12.7	0.92	23.4	1750	7000	5.5	140	0.37	BN
S210-12	5/8	15.9	1.08	27.4	1500	6000	6.5	165	0.45	BN
S210-16	7/8	22.2	1.24	31.5	800	3200	7.4	188	0.47	BN
S210-20	1-1/8	28.6	1.50	38.1	625	2500	9.0	229	0.52	BN
S210-24	1-3/8	34.9	1.75	44.5	500	2000	10.5	267	0.67	BN
S210-32	1-13/16	46.0	2.22	56.4	350	1400	13.3	338	0.92	BN

SUCTION HOSE

S040 SAE 100R4 SUCTION & RETURN HOSE

APPLICATION Hydraulic systems with petroleum or water/glycol based fluids and for fuel and lubricating oils.
TUBE Oil resistant special synthetic rubber.
REINFORCEMENT Multiple layers of textile braids with wire helix.
COVER Oil, abrasion and weather resistant synthetic rubber.
TEMPERATURE (-40°C to 121°C) (-40°F to 212°F) *intermittent 125°C (257°F)

Part No.	I.D. in	I.D. mm	O.D. in	O.D. mm	Max. W.P. psi	Min. Burst psi	Min. Bend Radius (in)	Min. Bend Radius (mm)	Weight lbs./ft.
S040-12	3/4	19.0	1.14	29.0	300	1200	5	127	0.50
S040-16	1	25.4	1.39	35.3	250	1000	6	152	0.60
S040-20	1-1/4	31.8	1.64	41.7	200	800	8	203	0.80
S040-24	1-1/2	38.1	1.93	49.0	150	600	10	254	0.90
S040-32	2	51.0	2.44	62.0	100	400	12	305	1.20

PUSH-ON HOSE

100R6 RUBBER COVER PUSH-ON

APPLICATION Petroleum base hydraulic fluids and lubricating oils. For low pressure hydraulic and pneumatic systems, shop, air, general industrial and automotive.
TUBE Oil resistant synthetic rubber.
REINFORCEMENT Textile Braids
COVER Oil, weather resistant synthetic rubber.
COLORS Black.
TEMPERATURE (-35°C to + 80°C) (-30°F to +176°F)

Part No.	I.D. in	I.D. mm	O.D. in	O.D. mm	Max W.P. psi	Min. Burst psi	Weight lbs./ft.
S100-04	1/4	6.4	0.50	13	250	1000	0.09
S100-05	5/16	7.9	0.56	14	250	1000	0.10
S100-06	3/8	9.5	0.63	16	250	1000	0.12
S100-08	1/2	12.7	0.78	20	250	1000	0.17
S100-10	5/8	15.9	0.91	23	250	1000	0.20
S100-12	3/4	19.1	1.03	26	250	1000	0.24

THERMOPLASTIC HYDRAULIC HOSE

S700 SAE 100R7

APPLICATION Petroleum based hydraulic fluids, water, and a wide range of chemicals.
 TUBE Polyester
 REINFORCEMENT Braided polyester
 COVER Black perforated polyurethane.
 TEMPERATURE (-40°C to +100°C), (-40°F to +212°F)

Part No.	I.D. in	I.D. mm	O.D. in	O.D. mm	Max. W.P. psi	Min. Burst psi	Min. Bend Radius (in)	Min. Bend Radius (mm)	Weight lbs./ft.	Coupling Series
S700-02	1/8	3.2	0.32	8.1	3000	12000	0.5	13	.03	T
S700-03	3/16	4.8	0.40	10.2	3000	12000	0.8	20	.04	T
S700-04	1/4	6.4	0.50	12.7	3000	12000	1.3	32	.06	T
S700-05	5/16	7.9	0.58	14.7	2500	10000	1.8	46	.08	T
S700-06	3/8	9.5	0.65	16.5	2250	9000	2.0	51	.09	T
S700-08	1/2	12.7	0.82	20.8	2000	8000	3.0	76	.14	T
S700-12	3/4	19.1	1.07	27.2	1250	5000	5.0	127	.19	T

THERMOPLASTIC HYDRAULIC HOSE

S710 SAE 100R7 NON-CONDUCTIVE

APPLICATION Petroleum based hydraulic fluids for telephone and power line servicing vehicles.
 TUBE Polyester
 REINFORCEMENT Braided polyester
 COVER Orange, non perforated polyurethane cover that meets SAE J517 non-conductivity requirements.
 TEMPERATURE (-40°C to +100°C), (-40°F to +212°F)

Part No.	I.D. in	I.D. mm	O.D. in	O.D. mm	Max. W.P. psi	Min. Burst psi	Min. Bend Radius (in)	Min. Bend Radius (mm)	Weight lbs./ft.	Coupling Series
S710-04	1/4	6.3	.50	12.7	3300	13200	1.3	33	0.06	T
S710-05	5/16	7.9	.58	14.7	3000	12000	1.8	46	0.08	T
S710-06	3/8	9.5	.65	16.5	3000	12000	2.0	51	0.09	T
S710-08	1/2	12.7	.82	20.8	2000	8000	3.0	76	0.14	T

THERMOPLASTIC HYDRAULIC HOSE

S720 SAE 100R7 TWIN LINE

APPLICATION Petroleum based hydraulic fluids, water, diesel fuels and lubricating oils.
TUBE Polyester
REINFORCEMENT One braid, synthetic fiber.
COVER Black polyurethane.
TEMPERATURE (-40°C to +100°C), (-40°F to +212°F)

Part No.	I.D. in	I.D. mm	O.D. in	O.D. mm	Max. W.P. psi	Min. Burst psi	Min. Bend Radius (in)	Min. Bend Radius (mm)	Weight lbs./ft.	Coupling Series
S720-04	1/4	6.3	0.50	12.7	3000	12000	1.3	33	0.12	T
S720-05	5/16	7.9	0.60	15.2	3000	12000	1.8	46	0.16	T
S720-06	3/8	9.5	0.63	16.0	3000	12000	2.0	51	0.19	T
S720-08	1/2	12.7	0.79	20.1	2000	8000	3.0	76	0.28	T

THERMOPLASTIC HYDRAULIC HOSE

S800 SAE 100R8

APPLICATION Petroleum based hydraulic fluids, water, diesel fuels and lubricating oils.
TUBE Polyester
REINFORCEMENT Braided high tensile Aramid fiber.
COVER Black polyurethane, pin pricked
TEMPERATURE (-40°C to +100°C), (-40°F to +212°F)

Part No.	I.D. in	I.D. mm	O.D. in	O.D. mm	Max. W.P. psi	Min. Burst psi	Min. Bend Radius (in)	Min. Bend Radius (mm)	Weight lbs./ft.	Coupling Series
S800-04	1/4	6.3	.47	11.9	5000	20000	2.0	51	.06	T
S800-06	3/8	9.5	.65	16.5	4000	16000	2.5	64	.09	T
S800-08	1/2	12.7	.79	20.1	3500	14000	4.0	102	.14	T
S800-12	3/4	19.1	1.10	27.9	2250	9000	6.5	165	.19	T

BOP - BLOW OUT PREVENTER HOSE

BOP - BLOW OUT PREVENTER

APPLICATION Drilling Rig Blow Out Preventer Hose.
TUBE Black, oil resistant nitrile rubber.
REINFORCEMENT Two high tensile steel wire braids.
COVER Extra heavy fire resistant neoprene rubber.
TEMPERATURE (-40°C to +120°C), (-40°F to 248°F)

Tested to Lloyd's & ERCB requirements of 700°C (130 0°F) over open flame for minimum 5 minutes.

Part No.	I.D. in	I.D. mm	O.D. in	O.D. mm	Max. W.P. psi	Min. Burst psi	Weight lbs./ft.	Coupling Series
S510-06	3/8"	9.5	1.13	28.7	3000	12000	.78	K
S510-08	1/2"	12.7	1.20	30.5	3000	12000	.84	K
S510-12	3/4"	19.1	1.50	38.1	3000	12000	1.25	K
S510-16	1"	25.4	1.85	47.0	3000	12000	1.75	K

OILFIELD KELLY HOSE

KELLY HOSE - 2"

APPLICATION Hydraulic systems with petroleum or water/glycol based fluids and for fuel and lubricating oils.
TUBE Nitrile
REINFORCEMENT Four spirals of high tensile wire.
COVER Black neoprene, MSHA approved.
TEMPERATURE (-40°C to +121°C), (-40°F to +250°F)

Part No.	I.D. in	I.D. mm	O.D. in	O.D. mm	Max. W.P. psi	Min. Burst psi	Min. Bend Radius (in)	Min. Bend Radius (mm)	Weight lbs./ft.	Coupling Series
S920-32	2	50.8	2.68	68.1	3600	14400	25.0	635	2.78	X

GREASE HOSE

S020 GREASE HOSE

APPLICATION Petroleum based hydraulic fluids, water, and a wide range of chemicals.
TUBE Polyester
REINFORCEMENT One braid, synthetic fiber.
COVER Black polyurethane.
TEMPERATURE (-40°C to +100°C), (-40°F to +212°F)

Part No.	I.D. in	I.D. mm	O.D. in	O.D. mm	Max. W.P. psi	Min. Burst psi	Min. Bend Radius (in)	Min. Bend Radius (mm)	Weight lbs./ft.	Coupling Series
S020-02	1/8	3.2	.34	8.6	3000	12000	.50	13	.03	K

PRESSURE WASHER HOSE

S320 PRESSURE WASHER HOSE

APPLICATION Water cleaning Equipment within a temp. range of +121°C (250°F).
 TUBE Synthetic Rubber
 REINFORCEMENT 1W/B (One braid of high tensile steel wire).
 COVER Weather and abrasion resistant synthetic rubber.
 COLOR Blue or Black
 TEMPERATURE Hot Water +121°C (250°F) * not recommend ed for steam service.

Part No.	I.D. in	I.D. mm	O.D. in	O.D. mm	Max. W.P. psi	Min. Burst psi	Min. Bend Radius (in)	Min. Bend Radius (mm)	Weight lbs./ft.	Coupling Series
S320-04	1/4	6.4	0.50	12.7	3000	12 000	2	51	0.13	K
S320-06	3/8	9.5	0.65	16.5	3000	12 000	2.5	64	0.22	K
S320-08	1/2	12.7	0.78	19.8	2500	10 000	3.5	89	0.31	K

STEAM PRESSURE WASHER HOSE

S330 STEAM PRESSURE WASHER HOSE

APPLICATION Steam cleaner machines or combination of steam cleaner/ pressure washer machines within a temp. range of (-40°F to +190°F) (-40°C to +375°C).
 TUBE Synthetic rubber specially designed for high pressure water and steam cleaning service.
 REINFORCEMENT 1 Wire Braid of high tensile steel wire.
 COVER Weather and abrasion resistant synthetic rubber.
 COLOR Black
 TEMPERATURE (-40°F to +190°F) (-40°C to +375°C)

Part No.	I.D. in	I.D. mm	O.D. in	O.D. mm	Max. W.P. psi	Min. Burst psi	Min. Bend Radius (in)	Min. Bend Radius (mm)	Weight lbs./ft.	Coupling Series
S330-06	3/8	9.5	0.65	16.5	3000	12 000	2.3	58	0.22	K

TEFLON HOSE

S090 SAE 100R14 SS TEFLON®

APPLICATION Steam, chemical, automotive, food processing, pharmaceutical and petroleum based hydraulic fluids.
 TUBE Smooth bore teflon.
 COVER One braid of high tensile stainless steel wire.
 TEMPERATURE (-54°C to +232°C), (-65°F to +450°F) continuous; -73°C to +260°C, (-100°F to +500°F) intermittent service

Part No.	I.D. in	O.D. in	Max. W.P. psi	Min. Burst psi	Min. Bend Radius (in)	Weight lbs./ft.	Coupling Series
S090-04	3/16	.32	3000	12000	2.0	.07	T
S090-05	1/4	.38	3000	12000	3.0	.10	T
S090-06	5/16	.44	2500	10000	4.0	.11	T
S090-08	13/32	.54	2000	8000	5.0	.12	T
S090-10	1/2	.65	1500	6000	7.0	.15	T
S090-12	5/8	.77	1200	4800	8.0	.17	T
S090-16	7/8	1.03	1000	4000	9.0	.25	T

CRIMP FITTING COMPATABILITY

		HOSE PART NUMBER	WORKING PRESSURE	FITTING SERIES	
S311	ONE WIRE BRAID SAE 100R1AT EN 853 1SN	S311-04	3263	K....SERIES	NO SKIVE
		S311-06	2610		
		S311-08	2320		
		S311-10	1885		
		S311-12	1523		
		S311-16	1276		
		S311-20	914		
		S311-24	725		
		S311-32	580	J....SERIES	NO SKIVE
S421	TWO WIRE BRAID SAE 100R2AT EN 853 2SN	S421-04	5800	K....SERIES	NO SKIVE
		S421-06	4785		
		S421-08	3988		
		S421-10	3625		
		S421-12	3118		
		S421-16	2393		
		S421-20	1813		
		S421-24	1305		
		S421-32	1131	J....SERIES	NO SKIVE
S470	CONSTANT PRESSURE SAE 100R17	S470-04	3045	K....SERIES	NO SKIVE
		S470-06	3045		
		S470-08	3045		
		S470-10	3045		
		S470-12	3045		
		S470-16	3045		
S490	ULTIMATE TWO WIRE	S490-04	6500	K....SERIES	NO SKIVE
		S490-06	5600		
		S490-08	5000		
		S490-10	4205		
		S490-12	4000		
		S490-16	3000		
S900	FOUR SPIRAL SAE 100R12	S900-06	4000	J.... SERIES OR	NO SKIVE
		S900-08	4000		
		S900-10	4000		
		S900-12	4000		
		S900-16	4000	X....SERIES	SKIVE
		S900-20	3000		
		S900-24	2500		
		S900-32	2500		
S920	FOUR SPIRAL EN 856 4SP/4SH	S920-12	6090	X....SERIES OR	SKIVE
		S920-16	5510		
		S920-20	5075	H....SERIES	NO SKIVE
		S920-24	4205		
		S920-32	3625		
S970	FOUR/SIX SPIRAL SAE 100R13	S970-12	5000	X....SERIES OR	SKIVE
		S970-16	5000		
		S970-20	5000	H....SERIES	NO SKIVE
		S970-24	5000		
		S970-32	5000		
S990	FOUR/SIX SPIRAL SAE 100R15	S990-12	6090	X....SERIES OR	SKIVE
		S990-16	6090		
		S990-20	6090	H....SERIES	NO SKIVE
		S990-24	6090		
		S990-32	6090		

CRIMP FITTINGS

K - 1 & 2 WIREHOSE
 J - 4 SPIRAL HOSE - NOSKIVE
 X - 4 & 6 SPIRAL HOSE - SKIVE
 H - 4 & 6 SPIRAL HOSE - NO SKIVE

(1)	(2)
HOSE I.D.	NPTF THREAD
04 - 1/4"	02 - 1/8" - 27
05 - 5/16"	04 - 1/4" - 18
06 - 3/8"	06 - 3/8" - 18
08 - 1/2"	08 - 1/2" - 14
10 - 5/8"	12 - 3/4" - 14
12 - 3/4"	16 - 1" - 11-1/2
16 - 1"	20 - 1-1/4" - 11-1/2
20 - 1-1/4"	24 - 1-1/2" - 11-1/2
24 - 1-1/2"	32 - 2" - 11-1/2
32 - 2"	

NPT MALE SWIVEL

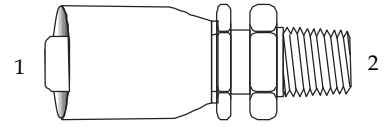

- (1) (2)
 K04-02MPX
 K04-04MPX
 K04-06MPX
 K06-04MPX
 K06-06MPX
 K06-08MPX
 K08-06MPX
 K08-08MPX
 K10-12MPX
 K12-08MPX
 K12-12MPX
 K16-16MPX

NPT MALE

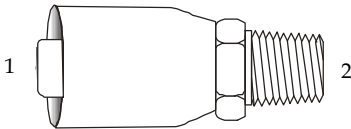

(1) (2)	(1) (2)	(1) (2)	(1) (2)
K04-02MP	J06-04MP	X12-12MP	H20-20MP
K04-04MP	J06-06MP	X16-16MP	H24-24MP
K04-06MP	J06-08MP	X20-20MP	H32-32MP
K04-08MP	J08-06MP	X24-24MP	
K06-04MP	J08-08MP	X32-32MP	
K06-06MP	J08-12MP		
K06-08MP	J10-08MP		
K08-04MP	J10-12MP		
K08-06MP	J12-12MP		
K08-08MP	J12-16MP		
K08-12MP	J16-12MP		
K10-08MP	J16-16MP		
K10-12MP	J16-20MP		
K12-08MP	J20-20MP		
K12-12MP	J20-24MP		
K12-16MP	J24-24MP		
K16-12MP	J32-32MP		
K16-16MP			
K16-20MP			

NPSM FEMALE SWIVEL

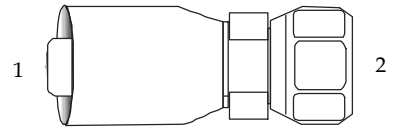

- (1) (2)
 K04-04FPX
 K06-06FPX
 K06-08FPX
 K08-08FPX
 K08-12FPX
 K12-12FPX
 K16-16FPX

NPSM FEMALE RIGID

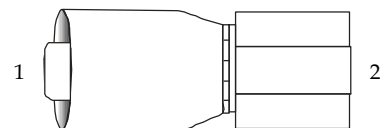

- (1) (2)
 K04-02FP
 K04-04FP
 K04-06FP
 K06-04FP
 K06-06FP
 K06-08FP
 K08-06FP
 K08-08FP
 K12-12FP

CRIMP FITTINGS

JIC 37° FEMALE SWIVEL

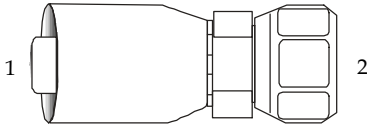

(1) (2)	(1) (2)	(1) (2)	(1) (2)
K04-04FJ	J06-04FJ	X12-12FJ	H20-20FJ
K04-05FJ	J06-06FJ	X16-16FJ	H20-24FJ
K04-06FJ	J06-08FJ	X16-20FJ	H24-24FJ
K06-04FJ	J06-10FJ	X20-20FJ	H32-32FJ
K06-05FJ	J08-06FJ	X20-24FJ	
K06-06FJ	J08-08FJ	X24-24FJ	
K06-08FJ	J08-10FJ	X32-32FJ	
K06-10FJ	J08-12FJ		
K08-06FJ	J10-08FJ		
K08-08FJ	J10-10FJ		
K08-10FJ	J10-12FJ	(1)	(2)
K08-12FJ	J12-10FJ	HOSE I.D.	JIC THREADS
K10-08FJ	J12-12FJ	04 - 1/4"	02 - 5/16 - 24
K10-10FJ	J12-14FJ	05 - 5/16"	03 - 3/8 - 24
K10-12FJ	J12-16FJ	06 - 3/8"	04 - 7/16 - 20
K12-10FJ	J16-12FJ	08 - 1/2"	05 - 1/2 - 20
K12-12FJ	J16-16FJ	10 - 5/8"	06 - 9/16 - 18
K12-14FJ	J16-20FJ	12 - 3/4"	08 - 3/4 - 16
K12-16FJ	J20-16FJ	16 - 1"	10 - 7/8 - 14
K16-12FJ	J20-20FJ	20 - 1-1/4"	12 - 1-1/16 - 12
K16-16FJ	J20-24FJ	24 - 1-1/2"	14 - 1-3/16 - 12
K16-20FJ	J24-24FJ	32 - 2"	16 - 1-5/16 - 12
	J32-32FJ		20 - 1-5/8 - 12
			24 - 1-7/8 - 12
			32 - 2-1/2 - 12

JIC 37° FEMALE 90° ELBOW

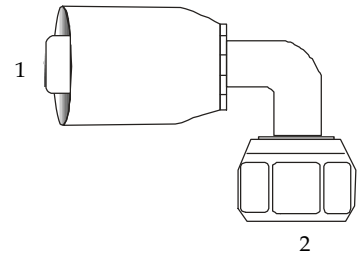

(1) (2)	(1) (2)	(1) (2)	(1) (2)
K04-04FJ90	J06-06FJ90	X12-12FJ90	H20-20FJ90
K04-05FJ90	J06-08FJ90	X16-16FJ90	H24-24FJ90
K04-06FJ90	J06-10FJ90	X20-20FJ90	H32-32FJ90
K06-06FJ90	J08-08FJ90	X24-24FJ90	
K06-08FJ90	J08-10FJ90	X32-32FJ90	
K06-10FJ90	J08-12FJ90		
K08-06FJ90	J10-10FJ90		
K08-08FJ90	J10-12FJ90		
K08-10FJ90	J12-10FJ90		
K08-12FJ90	J12-12FJ90		
K10-10FJ90	J12-16FJ90		
K10-12FJ90	J16-16FJ90		
K12-10FJ90	J16-20FJ90		
K12-12FJ90	J20-20FJ90		
K12-16FJ90	J20-24FJ90		
K16-16FJ90	J24-24FJ90		
K16-20FJ90	J32-32FJ90		

JIC 37° FEMALE 45° ELBOW

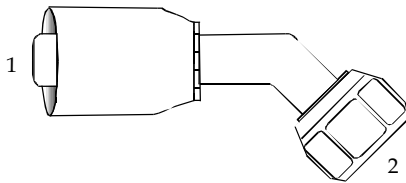

(1) (2)	(1) (2)	(1) (2)	(1) (2)
K04-04FJ45	J06-04FJ45	X12-12FJ45	H20-20FJ45
K04-05FJ45	J06-06FJ45	X16-16FJ45	H24-24FJ45
K04-06FJ45	J06-08FJ45	X20-20FJ45	H32-32FJ45
K06-04FJ45	J06-10FJ45	X24-24FJ45	
K06-06FJ45	J08-08FJ45	X32-32FJ45	
K06-08FJ45	J08-10FJ45		
K06-10FJ45	J10-10FJ45		
K08-08FJ45	J10-12FJ45		
K08-10FJ45	J12-12FJ45		
K10-10FJ45	J12-16FJ45		
K10-12FJ45	J16-16FJ45		
K12-12FJ45	J16-20FJ45		
K12-16FJ45	J20-20FJ45		
K16-16FJ45	J24-24FJ45		
	J32-32FJ45		

JIC 37° FEMALE 90° ELBOW LONG

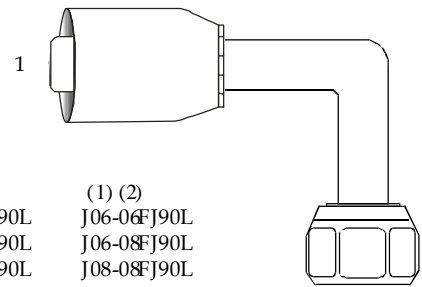

(1) (2)	(1) (2)
K04-04FJ90L	J06-06FJ90L
K04-05FJ90L	J06-08FJ90L
K04-06FJ90L	J08-08FJ90L
K05-06FJ90L	J08-10FJ90L
K06-06FJ90L	J10-10FJ90L
K06-08FJ90L	J10-12FJ90L
K08-08FJ90L	J12-12FJ90L
K08-10FJ90L	J16-16FJ90L
K10-10FJ90L	J16-20FJ90L
K10-12FJ90L	J20-20FJ90L
K12-12FJ90L	
K12-16FJ90L	
K16-16FJ90L	

K - 1 & 2 WIRE HOSE
 J - 4 SPIRAL HOSE - NO SKIVE
 X - 4 & 6 SPIRAL HOSE - SKIVE
 H - 4 & 6 SPIRAL HOSE - NO SKIVE

CRIMP FITTINGS

JIC MALE

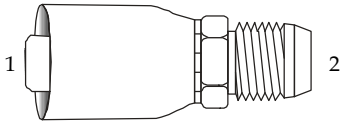

(1) (2)	(1) (2)	(1) (2)	(1) (2)
K04-04MJ	J06-06MJ	H20-20MJ	X12-12MJ
K04-05MJ	J06-08MJ	H24-24MJ	X16-16MJ
K04-06MJ	J06-10MJ	H32-32MJ	X20-20MJ
K06-06MJ	J08-08MJ		X24-24MJ
K06-08MJ	J08-10MJ		X32-32MJ
K06-10MJ	J08-12MJ		
K08-06MJ	J10-08MJ		
K08-08MJ	J10-10MJ		
K08-10MJ	J10-12MJ		
K08-12MJ	J12-10MJ		
K10-08MJ	J12-12MJ		
K10-10MJ	J12-14MJ		
K10-12MJ	J12-16MJ		
K12-10MJ	J16-16MJ		
K12-12MJ	J16-20MJ		
K12-14MJ	J20-20MJ		
K12-16MJ	J24-24MJ		
K16-16MJ	J32-32MJ		
K16-20MJ			

O-RING BOSS MALE

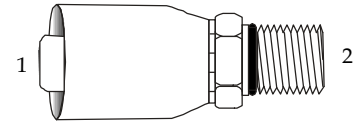

(1) (2)	(1) (2)
K04-04MOB	J06-06MOB
K04-05MOB	J06-08MOB
K04-06MOB	J08-08MOB
K06-06MOB	J10-10MOB
K06-08MOB	J10-12MOB
K06-10MOB	J12-12MOB
K08-08MOB	J16-16MOB
K08-10MOB	
K08-12MOB	
K10-10MOB	
K10-12MOB	
K12-12MOB	
K12-14MOB	
K12-16MOB	
K16-16MOB	

SAE FLARELESS COMPRESSION

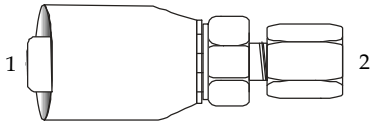

(1) (2)
K04-04MRNS
K06-05MRNS
K06-06MRNS
K08-08MRNS
K08-10MRNS
K12-12MRNS

O-RING BOSS MALE SWIVEL

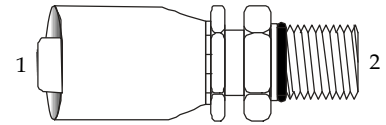

(1) (2)
K04-04MOBX
K06-06MOBX
K06-08MOBX
K08-08MOBX
K08-10MOBX
K12-12MOBX

ORFS FEMALE SWIVEL

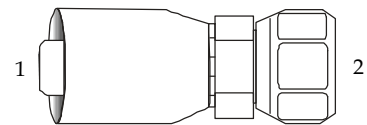

SAE 45° FEMALE SWIVEL

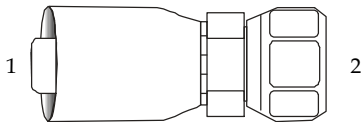

(1) (2)	
K04-06FA	
K06-06FA	
K06-08FA	
K08-08FA	K - 1 & 2 WIRE HOSE
K08-10FA	J - 4 SPIRAL HOSE - NO SKIVE
K10-12FA	X - 4 & 6 SPIRAL HOSE - SKIVE
K12-12FA	H - 4 & 6 SPIRAL HOSE - NO SKIVE

(1) (2)	(1) (2)	(1) (2)	(1) (2)
K04-04FF	J06-06FF	X12-12FF	H20-20FF
K04-06FF	J06-08FF	X16-16FF	H24-24FF
K06-04FF	J08-06FF	X20-20FF	
K06-06FF	J08-08FF	X24-24FF	
K06-08FF	J08-10FF		
K08-06FF	J08-12FF		
K08-08FF	J10-10FF		
K08-10FF	J10-12FF		
K08-12FF	J12-10FF		
K10-10FF	J12-12FF		
K10-12FF	J12-16FF		
K12-10FF	J16-12FF		
K12-12FF	J16-16FF		
K12-16FF	J16-20FF		
K16-16FF	J20-20FF		
	J20-24FF		
	J24-24FF		

CRIMP FITTINGS

ORFS FEMALE 45° ELBOW

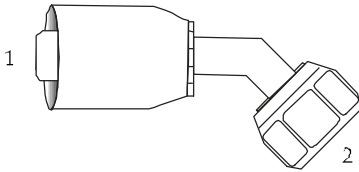

(1) (2)	(1) (2)	(1) (2)	(1) (2)
K04-04FF45	J06-06FF45	X12-12FF45	H20-20FF45
K04-06FF45	J06-08FF45	X16-16FF45	H24-24FF45
K06-06FF45	J08-08FF45	X20-20FF45	
K06-08FF45	J08-10FF45	X24-24FF45	
K08-06FF45	J08-12FF45		
K08-08FF45	J10-10FF45		
K08-10FF45	J10-12FF45		
K10-10FF45	J12-12FF45		
K10-12FF45	J16-16FF45		
K12-12FF45	J20-20FF45		
K12-16FF45	J24-24FF45		
K16-16FF45			

ORFS FEMALE 90° ELBOW LONG

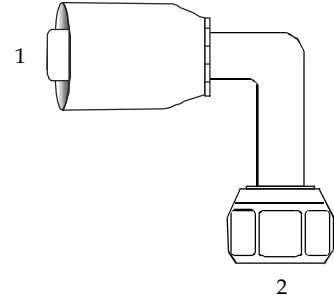

(1) (2)	(1) (2)
K04-04FF90L	J08-08FF90L
K04-06FF90L	J08-10FF90L
K06-06FF90L	J12-12FF90L
K06-08FF90L	J12-16FF90L
K08-08FF90L	J16-16FF90L
K08-10FF90L	J20-20FF90L
K10-10FF90L	
K12-12FF90L	
K16-16FF90L	

ORFS FEMALE SWIVEL - 90° ELBOW

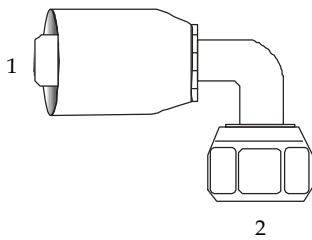

(1) (2)	(1) (2)	(1) (2)	(1) (2)
K04-04FF90	J06-06FF90	X12-12FF90	H20-20FF90
K04-06FF90	J06-08FF90	X16-16FF90	H24-24FF90
K06-04FF90	J08-08FF90	X20-20FF90	
K06-06FF90	J08-10FF90	X24-24FF90	
K06-08FF90	J08-12FF90		
K08-06FF90	J10-10FF90		
K08-08FF90	J10-12FF90		
K08-10FF90	J12-10FF90		
K08-12FF90	J12-12FF90		
K10-10FF90	J12-16FF90		
K10-12FF90	J16-16FF90		
K12-10FF90	J16-20FF90		
K12-12FF90	J20-20FF90		
K12-16FF90	J24-24FF90		
K16-16FF90			

ORFS MALE

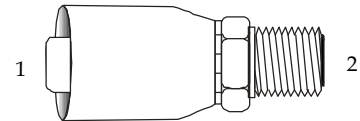

(1)(2)
K04-04MF
K04-06MF
K06-06MF
K06-08MF
K08-08MF
K08-10MF
K08-12MF
K10-10MF
K10-12MF
K12-12MF
K12-16MF
K16-16MF

MALE INVERTED FLARE

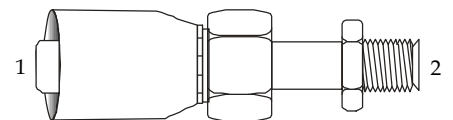

(1) (2)
K04-04MIX
K04-05MIX
K06-05MIX
K06-06MIX
K08-08MIX

K - ONE & TWOWIRE HOSE
 J - 4 SPIRAL HOSE - NOSKIVE
 X - 4 & 6 SPIRAL HOSE -SKIVE
 H - 4 & 6 SPIRALHOSE - NO SKIVE

CRIMP FITTINGS

MALE INVERTED FLARE - 45° ELBOW

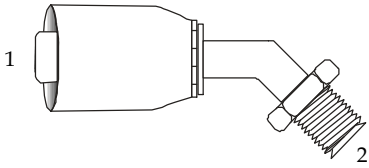

- (1) (2)
 K04-04MIX45
 K04-05MIX45
 K06-05MIX45
 K06-06MIX45
 K08-08MIX45

SAE CODE 61 FLANGE - 45° ELBOW

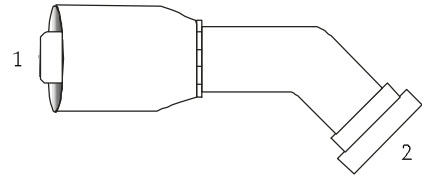

- | | | |
|------------|------------|------------|
| (1) (2) | (1) (2) | (1) (2) |
| K08-08FL45 | J08-08FL45 | X12-12FL45 |
| K08-12FL45 | J08-12FL45 | X12-16FL45 |
| K10-12FL45 | J10-12FL45 | X16-16FL45 |
| K12-12FL45 | J12-12FL45 | X20-20FL45 |
| K12-16FL45 | J12-16FL45 | X20-24FL45 |
| K16-16FL45 | J16-16FL45 | X24-24FL45 |
| K16-20FL45 | J16-20FL45 | X24-32FL45 |
| | J20-16FL45 | X32-32FL45 |
| | J20-20FL45 | |
| | J20-24FL45 | |
| | J24-24FL45 | |
| | J24-32FL45 | |
| | J32-24FL45 | |
| | J32-32FL45 | |

MALE INVERTED FLARE - 90° ELBOW

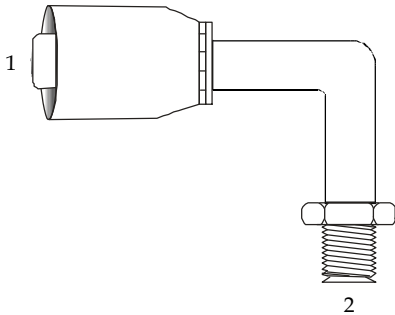

- (1) (2)
 K04-04MIX90
 K04-05MIX90
 K06-05MIX90
 K06-06MIX90
 K08-08MIX90

SAE CODE 61 FLANGE - 90° ELBOW

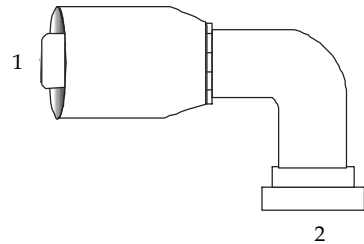

SAE CODE 61 FLANGE

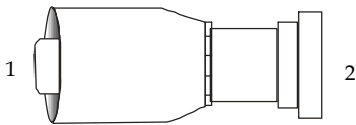

- | | | |
|----------|----------|----------|
| (1) (2) | (1) (2) | (1) (2) |
| K08-08FL | J08-08FL | X12-12FL |
| K08-12FL | J08-12FL | X16-16FL |
| K10-12FL | J10-12FL | X16-20FL |
| K12-12FL | J12-12FL | X20-20FL |
| K12-16FL | J12-16FL | X20-24FL |
| K16-16FL | J12-20FL | X24-24FL |
| K16-20FL | J16-16FL | X24-32FL |
| | J16-20FL | X32-24FL |
| | J16-24FL | X32-32FL |
| | J20-16FL | |
| | J20-20FL | |
| | J20-24FL | |
| | J20-32FL | |
| | J24-24FL | |
| | J24-32FL | |
| | J32-32FL | |
| | J32-40FL | |

- | | | |
|------------|------------|------------|
| (1) (2) | (1) (2) | (1) (2) |
| K08-08FL90 | J08-08FL90 | X12-12FL90 |
| K08-12FL90 | J08-12FL90 | X16-16FL90 |
| K10-12FL90 | J10-12FL90 | X20-20FL90 |
| K12-12FL90 | J12-12FL90 | X20-24FL90 |
| K12-16FL90 | J12-16FL90 | X24-24FL90 |
| K16-16FL90 | J12-20FL90 | X24-32FL90 |
| K16-20FL90 | J16-16FL90 | X32-32FL90 |
| | J16-20FL90 | |
| | J16-24FL90 | |
| | J20-16FL90 | |
| | J20-20FL90 | |
| | J20-24FL90 | |
| | J24-24FL90 | |
| | J24-32FL90 | |
| | J32-24FL90 | |
| | J32-32FL90 | |
| | J32-40FL90 | |

K - ONE & TWO WIRE HOSE
 J - 4 SPIRAL HOSE - NOSKIVE
 X - 4 & 6 SPIRAL HOSE - SKIVE
 H - 4 & 6 SPIRAL HOSE - NO SKIVE

CRIMP FITTINGS

SAE CODE 62 FLANGE

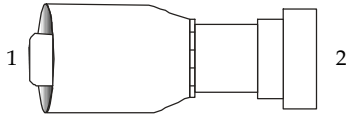

(1) (2)	(1) (2)
J08-08FLH	X12-12FLH
J08-12FLH	X12-16FLH
J10-12FLH	X16-16FLH
J12-12FLH	X16-20FLH
J12-16FLH	X20-20FLH
J16-16FLH	X20-24FLH
J16-20FLH	X24-24FLH
J20-16FLH	X24-20FLH
J20-20FLH	X24-24FLH
J20-24FLH	X24-32FLH
J24-24FLH	X32-32FLH
J24-32FLH	
J32-32FLH	

CAT STYLE FLANGE

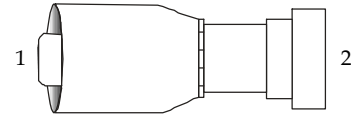

(1) (2)	(1) (2)
AY1CJ-12-12	AY1CX-12-12
AY1CJ-12-16	AY1CX-12-16
AY1CJ-16-16	AY1CX-16-16
AY1CJ-16-20	AY1CX-16-20
AY1CJ-20-20	AY1CX-20-20
AY1CJ-20-24	AY1CX-24-24
AY1CJ-24-24	AY1CX-24-32
AY1CJ-24-32	AY1CX-32-32
AY1CJ-32-32	

SAE CODE 62 FLANGE - 45° ELBOW

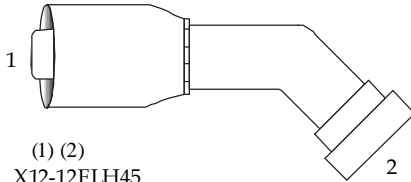

(1) (2)	(1) (2)
J08-08FLH45	X12-12FLH45
J08-12FLH45	X12-16FLH45
J10-12FLH45	X16-16FLH45
J12-12FLH45	X16-20FLH45
J12-16FLH45	X20-16FLH45
J16-12FLH45	X20-20FLH45
J16-16FLH45	X20-24FLH45
J16-20FLH45	X24-24FLH45
J20-16FLH45	X24-32FLH45
J20-20FLH45	X32-32FLH45
J20-24FLH45	
J24-24FLH45	
J24-32FLH45	
J32-32FLH45	

CAT STYLE FLANGE - 45° ELBOW

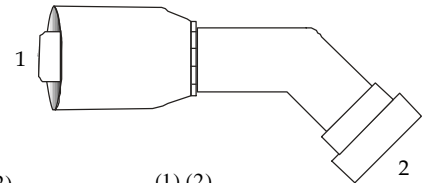

(1) (2)	(1) (2)
AY4CJ-12-12	AY4CX-12-12
AY4CJ-12-16	AY4CX-12-16
AY4CJ-16-16	AY4CX-16-16
AY4CJ-16-20	AY4CX-16-20
AY4CJ-20-16	AY4CX-20-16
AY4CJ-20-20	AY4CX-20-20
AY4CJ-20-24	AY4CX-24-24
AY4CJ-24-24	AY4CX-32-32
AY4CJ-24-32	
AY4CJ-32-32	

SAE CODE 62 FLANGE - 90° ELBOW

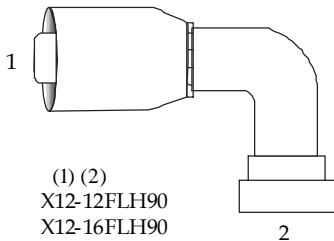

(1) (2)	(1) (2)
J08-08FLH90	X12-12FLH90
J08-12FLH90	X12-16FLH90
J10-12FLH90	X16-16FLH90
J12-12FLH90	X16-20FLH90
J12-16FLH90	X20-16FLH90
J16-16FLH90	X20-20FLH90
J16-20FLH90	X20-24FLH90
J20-16FLH90	X24-24FLH90
J20-20FLH90	X24-32FLH90
J20-24FLH90	X32-32FLH90
J24-24FLH90	
J24-32FLH90	
J32-32FLH90	

CAT STYLE FLANGE - 90° ELBOW

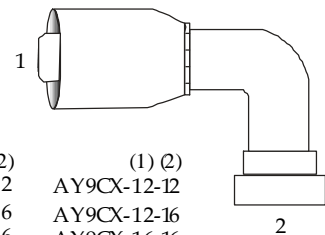

(1) (2)	(1) (2)
AY9CJ-12-12	AY9CX-12-12
AY9CJ-12-16	AY9CX-12-16
AY9CJ-16-16	AY9CX-16-16
AY9CJ-16-20	AY9CX-16-20
AY9CJ-20-20	AY9CX-20-20
AY9CJ-20-24	AY9CX-24-24
AY9CJ-24-24	AY9CX-32-32
AY9CJ-24-32	
AY9CJ-32-32	

K - ONE & TWO WIRE HOSE
 J - 4 SPIRAL HOSE - NO SKIVE
 X - 4 & 6 SPIRAL HOSE - SKIVE
 H - 4 & 6 SPIRAL HOSE - NOSKIVE

CRIMP FITTINGS

KOMATSU FLANGE

(1) (2)
K10-10FLK

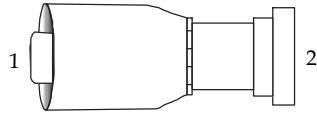

KOMATSU FLANGE 45° ELBOW

(1) (2)
K10-10FLK45

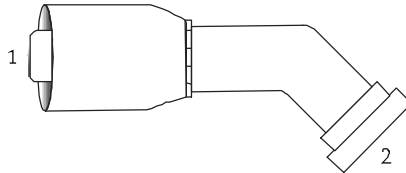

KOMATSU FLANGE 90° ELBOW

(1) (2)
K10-10FLK90

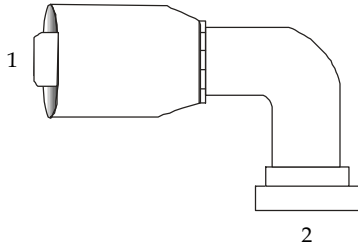

BSP FEMALE SWIVEL 60° CONE

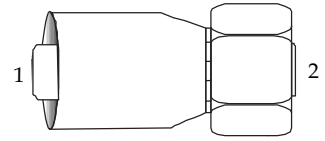

(1) (2)
K04-02FBSP
K04-04FBSP
K04-06FBSP
K06-04FBSP
K06-06FBSP
K06-08FBSP
K08-06FBSP
K08-08FBSP
K08-10FBSP
K08-12FBSP
K10-10FBSP
K10-12FBSP
K12-12FBSP
K12-16FBSP
K16-16FBSP

(1) (2)
J06-06FBSP
J06-08FBSP
J08-08FBSP
J08-10FBSP
J10-10FBSP
J10-12FBSP
J12-12FBSP
J12-16FBSP
J16-16FBSP
J16-20FBSP
J20-16FBSP
J20-20FBSP
J24-24FBSP
J32-32FBSP

BSP BANJO

(1) (2)
K04-02BJBSP
K04-04BJBSP
K04-06BJBSP
K06-06BJBSP
K06-08BJBSP
K08-08BJBSP
K10-10BJBSP
K12-12BJBSP
K16-16BJBSP

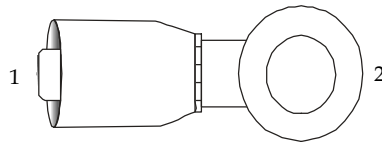

BSP FEMALE SWIVEL 60° CONE 45° ELBOW

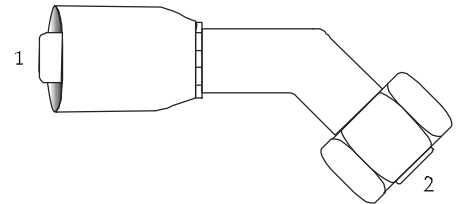

(1) (2)
K04-04FBSP45
K04-06FBSP45
K06-06FBSP45
K06-08FBSP45
K08-08FBSP45
K10-10FBSP45
K10-12FBSP45
K16-16FBSP45

(1) (2)
J06-06FBSP45
J06-08FBSP45
J08-08FBSP45
J10-10FBSP45
J10-12FBSP45
J12-12FBSP45
J16-16FBSP45
J20-20FBSP45
J24-24FBSP45
J32-32FBSP45

BSP TAPERED MALE 60° CONE

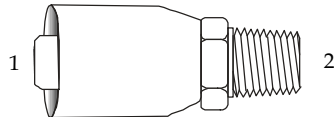

(1) (2)
K04-04MBSP
K04-06MBSP
K06-04MBSP
K06-06MBSP
K06-08MBSP
K08-06MBSP
K08-08MBSP
K08-12MBSP
K10-10MBSP
K10-12MBSP
K12-12MBSP
K16-16MBSP

(1) (2)
J06-04MBSP
J06-06MBSP
J06-08MBSP
J08-08MBSP
J10-10MBSP
J12-12MBSP
J12-16MBSP
J16-16MBSP
J20-16MBSP
J20-20MBSP
J24-24MBSP
J32-32MBSP

K - ONE & TWO WIRE HOSE
J - 4 SPIRAL HOSE - NO SKIVE
X - 4 & 6 SPIRAL HOSE - SKIVE
H - 4 & 6 SPIRAL HOSE - NOSKIVE

CRIMP FITTINGS

BSP FEMALE SWIVEL 60° CONE 90° ELBOW

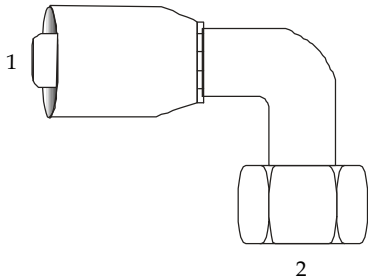

(1) (2)	(1) (2)
K04-04FBSP90	J06-06FBSP90
K04-06FBSP90	J06-08FBSP90
K06-06FBSP90	J08-08FBSP90
K06-08FBSP90	J10-10FBSP90
K08-08FBSP90	J10-12FBSP90
K08-10FBSP90	J12-12FBSP90
K10-10FBSP90	J16-16FBSP90
K10-12FBSP90	J20-20FBSP90
K12-12FBSP90	J24-24FBSP90
K12-16FBSP90	J32-32FBSP90
K16-16FBSP90	

BSP FLAT FACE FEMALE SWIVEL

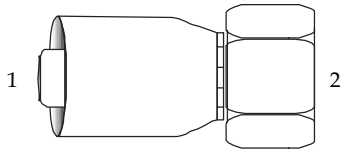

(1) (2)
K06-06FBFFF
K06-08FBFFF
K08-08FBFFF
K08-12FBFFF
K12-12FBFFF

BSP FLAT FACE MALE

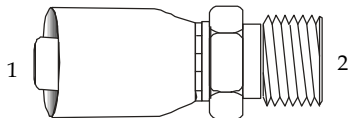

(1) (2)	(1) (2)
K06-06MBSPFF	J06-06MBSPFF
K06-08MBSPFF	J06-08MBSPFF
K08-08MBSPFF	J12-12MBSPFF
K12-16MBSPFF	J16-16MBSPFF
K16-16MBSPFF	

METRIC STANDPIPE

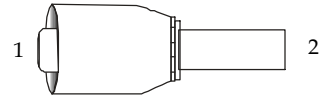

(1) (2)	(1) (2)	(1) (2)
K04-06FBSP90	K08-16FBSP90	K16-28FBSP90
K04-08FBSP90	K10-18FBSP90	K16-30FBSP90
K04-10FBSP90	K10-20FBSP90	
K05-10FBSP90	K12-18FBSP90	
K06-10FBSP90	K12-20FBSP90	
K06-12FBSP90	K12-22FBSP90	
K08-15FBSP90	K12-25FBSP90	

METRIC STANDPIPE 45° ELBOW

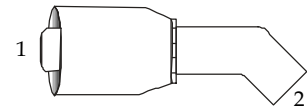

(1) (2)	(1) (2)	(1) (2)
K04-06FBSP90	K08-16FBSP90	K16-28FBSP90
K04-08FBSP90	K10-18FBSP90	K16-30FBSP90
K04-10FBSP90	K10-20FBSP90	
K05-10FBSP90	K12-18FBSP90	
K06-10FBSP90	K12-20FBSP90	
K06-12FBSP90	K12-22FBSP90	
K08-15FBSP90	K12-25FBSP90	

METRIC STANDPIPE 90° ELBOW

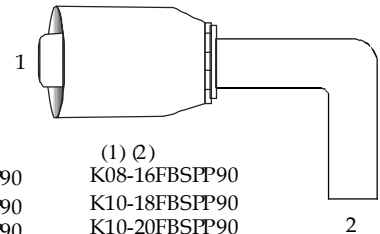

(1) (2)	(1) (2)	(1) (2)
K04-06FBSP90	K08-16FBSP90	K16-28FBSP90
K04-08FBSP90	K10-18FBSP90	K16-30FBSP90
K04-10FBSP90	K10-20FBSP90	
K05-10FBSP90	K12-18FBSP90	
K06-10FBSP90	K12-20FBSP90	
K06-12FBSP90	K12-22FBSP90	
K08-15FBSP90	K12-25FBSP90	

METRIC BANJO

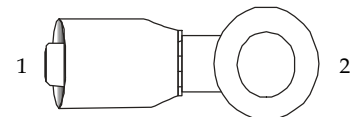

(1) (2)	(1) (2)
K04-12BJM	J06-14BJM
K06-14BJM	J06-16BJM
K06-16BJM	J06-18BJM
K06-18BJM	J06-22BJM
K08-18BJM	J10-22BJM
K08-22BJM	J12-26BJM
K10-22BJM	

CRIMP FITTINGS

METRIC LIGHT MALE (24° CONE SEAT)

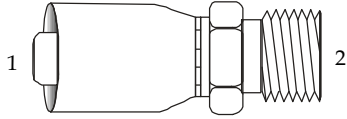

(1) (2)	(1) (2)
K04-12MML	J06-16MML
K04-14MML	J06-18MML
K04-16MML	J06-22MML
K06-16MML	J08-22MML
K06-18MML	J10-26MML
K06-22MML	J12-30MML
K08-18MML	J16-36MML
K08-22MML	J20-45MML
K10-26MML	J24-52MML
K12-30MML	
K16-36MML	

METRIC LIGHT FEMALE SWIVEL - 45° ELBOW (24° CONE SEAT)

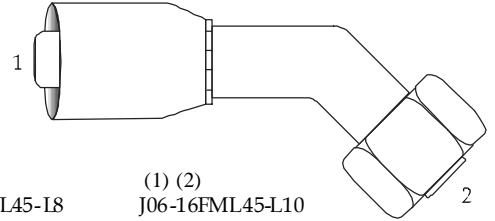

(1) (2)	(1) (2)
K04-14FML45-L8	J06-16FML45-L10
K04-16FML45-L10	J06-18FML45-L12
K04-18FML45-L12	J10-26FML45-L15
K06-16FML45-L10	J12-30FML45-L18
K06-18FML45-L12	J16-36FML45-L28
K08-22FML45-L12	J20-45FML45-L35
K10-26FML45-L15	J24-52FML45-L42
K12-30FML45-L18	

METRIC LIGHT FEMALE SWIVEL (24° CONE SEAT)

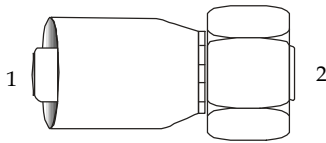

(1) (2)	(1) (2)
K04-12FML-L6	J06-16FML-L10
K04-14FML-L8	J06-18FML-L12
K04-16FML-L10	J06-22FML-L15
K04-18FML-L12	J08-22FML-L15
K06-16FML-L10	J10-26FML-L18
K06-18FML-L12	J12-30FML-L22
K06-22FML-L15	J16-36FML-L28
K08-22FML-L15	J20-45FML-L35
K08-26FML-L18	J24-52FML-L42
K10-26FML-L18	
K12-30FML-L22	
K16-36FML-L28	

METRIC LIGHT FEMALE SWIVEL - 90° ELBOW (24° CONE SEAT)

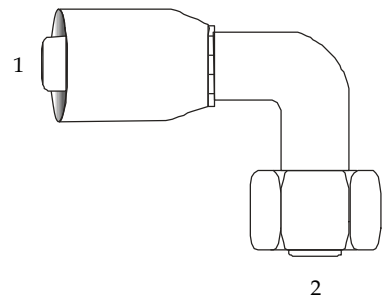

(1) (2)	(1) (2)
K04-14FML90-L8	J06-16FML90-L10
K04-16FML90-L10	J06-18FML90-L12
K06-16FML90-L10	J08-22FML90-L15
K06-18FML90-L12	J10-26FML90-L18
K08-22FML90-L15	J12-30FML90-L22
K08-26FML90-L18	J16-36FML90-L28
K10-26FML90-L18	J20-45FML90-L35
K12-30FML90-L22	J24-52FML90-L42
K16-36FML90-L28	

K - ONE & TWO WIRE HOSE
 J - 4 SPIRAL HOSE - NO SKIVE
 X - 4 & 6 SPIRAL HOSE - SKIVE
 H - 4 & 6 SPIRAL HOSE - NO SKIVE

CRIMP FITTINGS

METRIC HEAVY MALE (24° CONE SEAT)

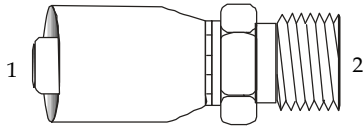

(1) (2)	(1) (2)
K04-14MMS	J06-18MMS
K04-16MMS	J06-20MMS
K04-18MMS	J06-22MMS
K04-20MMS	J06-24MMS
K06-18MMS	J08-24MMS
K06-20MMS	J10-30MMS
K06-22MMS	J12-30MMS
K06-24MMS	J12-36MMS
K08-24MMS	J16-36MMS
K10-30MMS	J16-42MMS
K12-30MMS	J20-52MMS
K12-36MMS	J24-52MMS
K16-36MMS	
K16-42MMS	

METRIC HEAVY FEMALE SWIVEL 45° ELBOW (24° CONE SEAT)

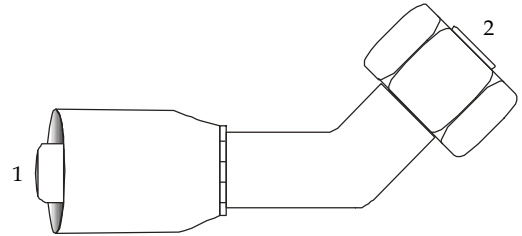

(1) (2)	(1) (2)
K04-14FMS45-S6	J06-20FMS45-S12
K04-16FMS45-S6	J06-22FMS45-S14
K04-18FMS45-S10	J08-24FMS45-S16
K06-20FMS45-S12	J10-30FMS45-S20
K06-22FMS45-S14	J12-36FMS45-S25
K08-24FMS45-S16	J16-42FMS45-S30
K10-30FMS45-S20	J20-52FMS45-S38
K12-30FMS45-S20	J24-52FMS45-S38
K12-36FMS45-S25	
K16-36FMS45-S25	
K16-42FMS45-S30	

METRIC HEAVY FEMALE SWIVEL (24° CONE SEAT)

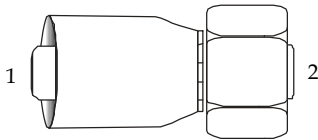

(1) (2)	(1) (2)
K04-14FMS-S6	J06-20FMS-S12
K04-16FMS-S8	J06-22FMS-S14
K04-18FMS-S10	J08-24FMS-S16
K06-18FMS-S10	J10-30FMS-S20
K06-20FMS-S12	J12-30FMS-S20
K06-22FMS-S14	J12-36FMS-S25
K08-24FMS-S16	J16-36FMS-S25
K10-30FMS-S20	J16-42FMS-S30
K12-30FMS-S20	J20-52FMS-S38
K12-36FMS-S25	J24-52FMS-S38
K16-36FMS-S25	
K16-42FMS-S30	

METRIC HEAVY FEMALE SWIVEL 90° ELBOW (24° CONE SEAT)

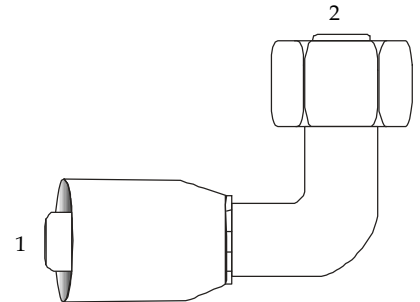

(1) (2)	(1) (2)
K04-14FMS90-S6	J06-20FMS90-S12
K04-16FMS90-S6	J06-22FMS90-S14
K04-18FMS90-S10	J08-24FMS90-S16
K06-18FMS90-S10	J10-30FMS90-S20
K06-20FMS90-S12	J12-30FMS90-S20
K06-22FMS90-S14	J12-36FMS90-S25
K08-24FMS90-S16	J16-36FMS90-S25
K10-30FMS90-S20	J16-42FMS90-S30
K12-30FMS90-S20	J20-52FMS90-S38
K12-36FMS90-S25	J24-52FMS90-S38
K16-36FMS90-S25	
K16-42FMS90-S30	

K - ONE & TWO WIRE HOSE
 J - 4 SPIRAL HOSE - NO SKIVE
 X - 4 & 6 SPIRAL HOSE - SKIVE
 H - 4 & 6 SPIRAL HOSE - NO SKIVE

REUSABLE COUPLINGS

For use on S200 & S210 100R5 Hose

NPTF MALE

(1) (2)	(1) (2)
BN04-02MP	BN10-12MP
BN04-04MP	BN12-08MP
BN05-04MP	BN12-12MP
BN06-04MP	BN16-12MP
BN06-06MP	BN16-16MP
BN08-06MP	BN20-20MP
BN08-08MP	BN24-24MP
BN10-08MP	BN32-32MP

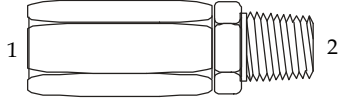

SAE 45° FEMALE SWIVEL

(1) (2)
BN04-04FA
BN05-05FA
BN06-06FA
BN08-08FA
BN10-10FA
BN12-12FA

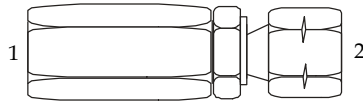

JIC 37° FEMALE

(1) (2)	(1) (2)
BN04-04FJ	BN10-08FJ
BN05-04FJ	BN10-10FJ
BN05-05FJ	BN12-12FJ
BN05-06FJ	BN16-16FJ
BN06-06FJ	BN20-20FJ
BN08-06FJ	BN24-24FJ
BN08-08FJ	BN32-32FJ

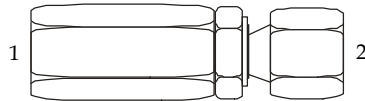

SAE 45° FEMALE SWIVEL 45° ELBOW

(1) (2)
BN04-04FA45
BN05-05FA45
BN06-06FA45
BN08-08FA45
BN10-10FA45
BN12-12FA45

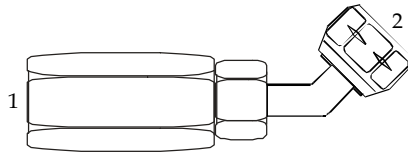

JIC 37° FEMALE SWIVEL 45° ELBOW

(1) (2)
BN04-04FJ45
BN05-05FJ45
BN06-06FJ45
BN08-08FJ45
BN10-10FJ45
BN12-12FJ45
BN16-16FJ45
BN20-20FJ45

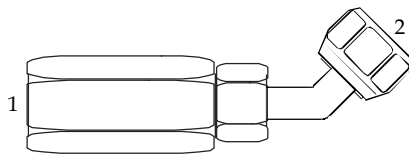

SAE 45° MALE

(1) (2)
BN04-04MA
BN05-05MA
BN06-06MA
BN08-08MA
BN10-10MA
BN12-12MA

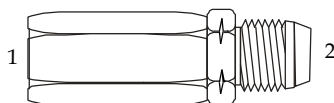

JIC 37° MALE

(1) (2)
BN04-04MJ
BN05-05MJ
BN06-06MJ
BN08-08MJ
BN10-10MJ
BN12-12MJ
BN16-16MJ

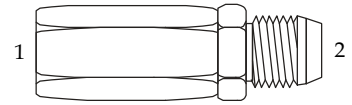

SAE 45° FEMALE SWIVEL 90° ELBOW

(1) (2)
BN04-04FA90
BN05-05FA90
BN06-06FA90
BN08-08FA90
BN10-10FA90
BN12-12FA90

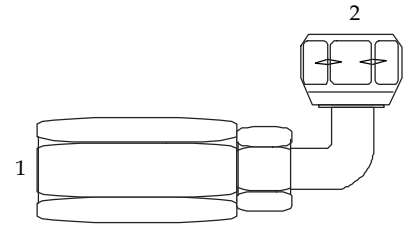

JIC 37° FEMALE SWIVEL 90° ELBOW

(1) (2)
BN04-04FJ90
BN05-05FJ90
BN06-06FJ90
BN08-08FJ90
BN12-12FJ90
BN16-16FJ90

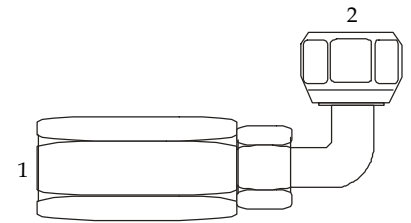

SAE 45° FEMALE SWIVEL 90° ELBOW LONG

(1) (2)
BN04-04FA90L
BN05-05FA90L
BN06-06FA90L
BN08-08FA90L
BN10-10FA90L
BN12-12FA90L

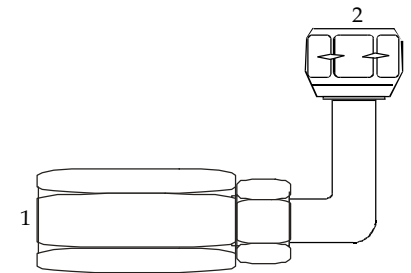

JIC 37° FEMALE SWIVEL 90° ELBOW LONG

(1) (2)
BN04-04FJ90L
BN05-05FJ90L
BN06-06FJ90L
BN08-08FJ90L
BN10-10FJ90L
BN12-12FJ90L
BN16-16FJ90L
BN20-20FJ90L

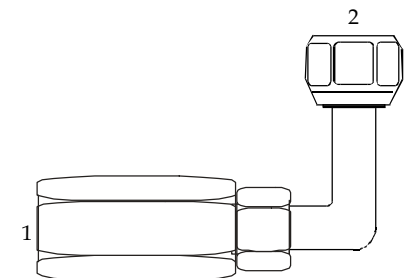

REUSABLE BRASS FITTINGS

For use on S100 Push-On Hose

NPTF MALE

	HOSE I.D.	PIPE
725-4A	1/4	1/8
725-4B	1/4	1/4
725-4C	1/4	3/8
725-6A	3/8	1/8
725-6B	3/8	1/4
725-6C	3/8	3/8
725-6D	3/8	1/2
725-8B	1/2	1/4
725-8C	1/2	3/8
725-8D	1/2	1/2
725-8E	1/2	3/4
725-10D	5/8	1/2
725-12D	3/4	1/2
725-12E	3/4	3/4

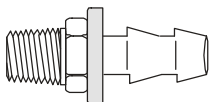

FEMALE INVERTED FLARE

	HOSE I.D.	TUBE
736-43	1/4	3/16
736-44	1/4	1/4
736-45	1/4	5/16
736-65	3/8	5/16
736-66	3/8	3/8

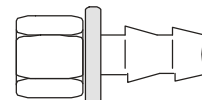

MALE INVERTED FLARE

	HOSE I.D.	TUBE
735-43	1/4	3/16
735-44	1/4	1/4
735-45	1/4	5/16
735-65	3/8	5/16
735-66	3/8	3/8
735-68	3/8	1/2
735-88	1/2	1/2
735-1010	5/8	5/8

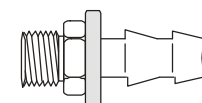

SAE 45° FEMALE SWIVEL

	HOSE I.D.	TUBE
728-44	1/4	1/4
728-45	1/4	5/16
728-66	3/8	3/8
728-68	3/8	1/2
728-86	1/2	3/8
728-88	1/2	1/2
728-810	1/2	5/8
728-108	5/8	1/2
728-1010	5/8	5/8
728-1212	3/4	3/4

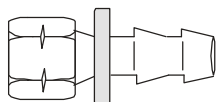

HOSE SPLICER

	HOSE I.D.
729-4	1/4
729-5	5/16
729-6	3/8
729-8	1/2
729-10	5/8
729-12	3/4

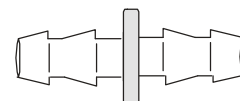

SAE 45° MALE

	HOSE I.D.	TUBE
727-44	1/4	1/4
727-45	1/4	5/16
727-65	3/8	5/16
727-66	3/8	3/8
727-88	1/2	1/2
727-810	1/2	5/8
727-1010	5/8	5/8

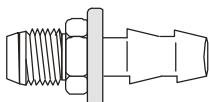

TUBE END

	HOSE I.D.	TUBE
732-43	1/4	3/16
732-44	1/4	1/4
732-45	1/4	5/16
732-66	3/8	3/8
732-88	1/2	1/2
732-1010	5/8	5/8

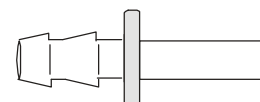

JIC 37° FEMALE

	HOSE I.D.	TUBE
738-44	1/4	1/4
738-45	1/4	5/16
738-66	3/8	3/8
738-88	1/2	1/2
738-1010	5/8	5/8
738-1212	3/4	3/4

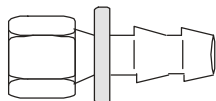

FEMALE PIPE SWIVEL BALL SEAT

	HOSE I.D.	PIPE
731-4A	1/4	1/8
731-4B	1/4	1/4
731-6B	3/8	1/4
731-6C	3/8	3/8
731-8D	1/2	1/2
731-12E	3/4	3/4

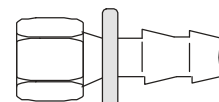

JIC 37° MALE

	HOSE I.D.	TUBE
737-44	1/4	1/4
737-45	1/4	5/16
737-66	3/8	3/8
737-88	1/2	1/2

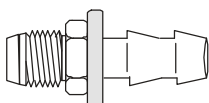

NPT FEMALE RIGID

	HOSE I.D.	PIPE
726-4A	1/4	1/8
726-4B	1/4	1/4
726-6B	3/8	1/4
726-6C	3/8	3/8
726-8C	1/2	3/8
726-8D	1/2	1/2
726-8E	1/2	3/4
726-12E	3/4	3/4

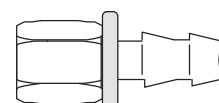

THREAD DIMENSIONS

PIPE THREAD

Dash Size	Pipe Size	Pitch (Threads/Inch)	Male Thread O.D.	Female Thread O.D.
02	1/8	27	0.41	0.37
04	1/4	18	0.54	0.49
06	3/8	18	0.68	0.62
08	1/2	14	0.84	0.76
12	3/4	14	1.06	0.98
16	1	11-1/2	1.31	1.24
20	1-1/4	11-1/2	1.66	1.58
24	1-1/2	11-1/2	1.90	1.82
32	2	11-1/2	2.38	2.28

O-RING FACE SEAL

Dash Size	Male Thread O.D.	Pitch (Threads/Inch)
04	9/16"	18
06	11/16"	16
08	13/16"	16
10	1"	14
12	1-3/16"	12
16	1-7/16"	12
20	1-11/16"	12
24	2"	12

JIC THREAD

Dash Size	Male Thread O.D.	Pitch (Threads/Inch)
02	5/16"	24
03	3/8"	24
04	7/16"	20
05	1/2"	20
06	9/16"	18
08	3/4"	16
10	7/8"	14
12	1-1/16"	12
14	1-3/16"	12
16	1-5/16"	12
20	1-5/8"	12
24	1-7/8"	12
32	2-1/2"	12

ORB THREAD

Dash Size	Male Thread O.D.	Pitch (Threads/Inch)
02	5/16"	24
03	3/8"	24
04	7/16"	20
05	1/2"	20
06	9/16"	18
08	3/4"	16
10	7/8"	14
12	1-1/16"	12
14	1-3/16"	12
16	1-5/16"	12
20	1-5/8"	12
24	1-7/8"	12
32	2-1/2"	12

INVERTED FLARE

Dash Size	Male Thread O.D.	Pitch (Threads/Inch)
02	5/16"	28
03	3/8"	24
04	7/16"	24
05	1/2"	20
06	5/8"	18
07	11/16"	18
08	3/4"	18
10	7/8"	18
12	1-1/16"	16

SAE 45° THREAD

Dash Size	Male Thread O.D.	Pitch (Threads/Inch)
02	5/16"	24
03	3/8"	24
04	7/16"	20
05	1/2"	20
06	5/8"	18
08	3/4"	16
10	7/8"	14
12	1-1/16"	14
14	1-1/4"	12
16	1-3/8"	12

METRIC THREAD LIGHT

DASH SIZE	TUBE O.D.	METRIC THREAD
06	06 mm	12 mm x 1.5
08	08 mm	14 mm x 1.5
10	10 mm	16 mm x 1.5
12	12 mm	18 mm x 1.5
15	15 mm	22 mm x 1.5
18	18 mm	26 mm x 1.5
22	22 mm	30 mm x 2.0
28	28 mm	36 mm x 2.0
35	35 mm	45 mm x 2.0
42	42 mm	52 mm x 2.0

METRIC THREAD HEAVY

DASH SIZE	TUBE O.D.	METRIC THREAD
06	06 mm	14 mm x 1.5
08	08 mm	16 mm x 1.5
10	10 mm	18 mm x 1.5
12	12 mm	20 mm x 1.5
14	14 mm	22 mm x 1.5
16	16 mm	24 mm x 1.5
20	20 mm	30 mm x 2.0
25	25 mm	36 mm x 2.0
30	30 mm	42 mm x 2.0
38	38 mm	52 mm x 2.0

BSPP THREAD

Dash Size	Pipe Size	Threads per inch	Pitch in.	Pitch mm	Outer Dia. in.	Outer Dia. mm
02	1/8	28	0.0357	0.907	0.3830	9.728
04	1/4	19	0.0526	1.337	0.5180	13.157
06	3/8	19	0.0526	1.337	0.6560	16.662
08	1/2	14	0.0714	1.814	0.8250	20.955
10	5/8	14	0.0714	1.814	0.9020	22.911
12	3/4	14	0.0714	1.814	1.0410	26.441
16	1	11	0.0909	2.309	1.3090	33.249
20	1-1/4	11	0.0909	2.309	1.6500	41.910
24	1-1/2	11	0.0909	2.309	1.8820	47.803
32	2	11	0.0909	2.309	2.3470	59.614

PIPE THREAD ADAPTERS-QUICK VIEW

Detailed Sizes on the following pages.

1404

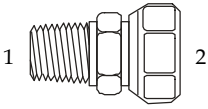

(1) Male Pipe
(2) Female Pipe

1405

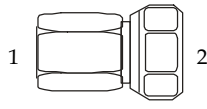

(1) Female Pipe
(2) Female Pipe

1501

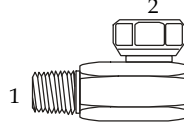

(1) Male Pipe
(2) Female Pipe

1501-L

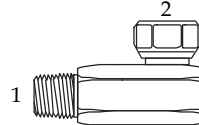

(1) Male Pipe
(2) Female Pipe

1502

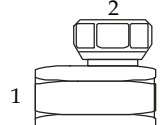

(1) Female Pipe
(2) Female Pipe

1503

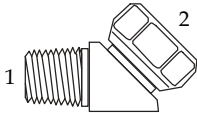

(1) Male Pipe
(2) Female Pipe

1504

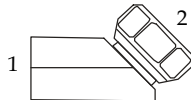

(1) Female Pipe
(2) Female Pipe

1601

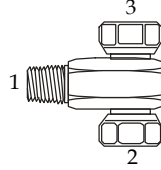

(1) Male Pipe
(2) (3) Female Pipe

1602

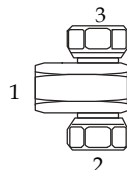

(1) Female Pipe
(2) (3) Female Pipe

1603

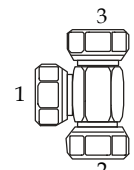

(1) (2) (3) Female Pipe

5000

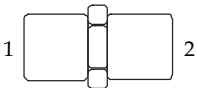

(1) (2) Female Pipe

5404

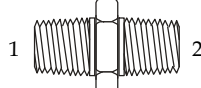

(1) (2) Male Pipe

5405

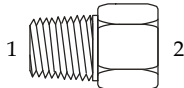

(1) Male Pipe
(2) Female Pipe

5406

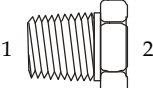

(1) Male Pipe
(2) Female Pipe

5406-P

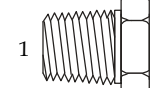

(1) Male Pipe

5406-HP

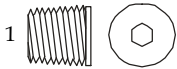

(1) Male Pipe

5406-SHP

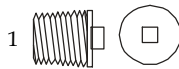

(1) Male Pipe

5500

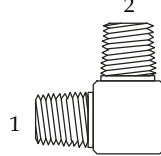

(1) (2) Male Pipe

5501

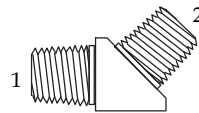

(1) (2) Male Pipe

5502

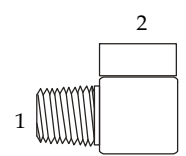

(1) Male Pipe
(2) Female Pipe

5503

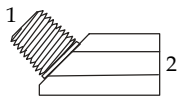

(1) Male Pipe
(2) Female Pipe

5504

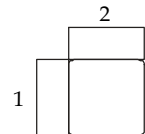

(1) (2) Female Pipe

5505

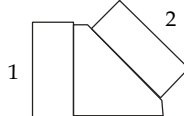

(1) (2) Female Pipe

5600

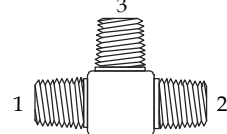

(1) (2) (3) Male Pipe

5601

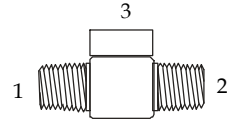

(1) (2) Male Pipe
(3) Female Pipe

5602

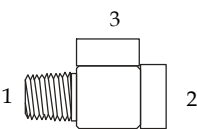

(1) Male Pipe
(2) (3) Female Pipe

5603

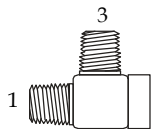

(1) (3) Male Pipe
(2) Female Pipe

5604

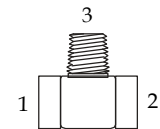

(1) (2) Female Pipe
(3) Male Pipe

5605

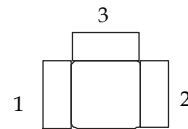

(1) (2) (3) Female Pipe

5650

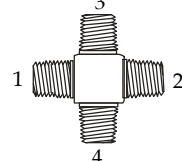

(1) (2) (3) (4) Male Pipe

5652

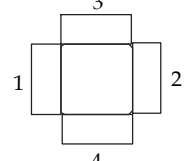

(1) (2) (3) (4) Female Pipe

PIPE THREAD ADAPTERS

1404 ...PIPE SWIVEL UNION

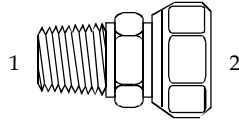

(1) (2)	MALE PIPE	FEMALE PIPE
1404-02-02	1/8" - 27	1/8" - 27
1404-02-04	1/8" - 27	1/4" - 18
1404-04-02	1/4" - 18	1/8" - 27
1404-04-04	1/4" - 18	1/4" - 18
1404-04-06	1/4" - 18	3/8" - 18
1404-04-08	1/4" - 18	1/2" - 14
1404-06-04	3/8" - 18	1/4" - 18
1404-06-06	3/8" - 18	3/8" - 18
1404-06-08	3/8" - 18	1/2" - 14
1404-08-04	1/2" - 14	1/4" - 18
1404-08-06	1/2" - 14	3/8" - 18
1404-08-08	1/2" - 14	1/2" - 14
1404-08-12	1/2" - 14	3/4" - 14
1404-12-06	3/4" - 14	3/8" - 18
1404-12-08	3/4" - 14	1/2" - 14
1404-12-12	3/4" - 14	3/4" - 14
1404-12-16	3/4" - 14	1" - 11-1/2
1404-12-20	3/4" - 14	1-1/4" - 11-1/2
1404-16-06	1" - 11-1/2	3/8" - 18
1404-16-08	1" - 11-1/2	1/2" - 14
1404-16-12	1" - 11-1/2	3/4" - 14
1404-16-16	1" - 11-1/2	1" - 11-1/2
1404-16-20	1" - 11-1/2	1-1/4" - 11-1/2
1404-16-24	1" - 11-1/2	1-1/2" - 11-1/2
1404-20-16	1-1/4" - 11-1/2	1" - 11-1/2
1404-20-20	1-1/4" - 11-1/2	1-1/4" - 11-1/2
1404-20-24	1-1/4" - 11-1/2	1-1/2" - 11-1/2
1404-24-20	1-1/2" - 11-1/2	1-1/4" - 11-1/2
1404-24-24	1-1/2" - 11-1/2	1-1/2" - 11-1/2
1404-24-32	1-1/2" - 11-1/2	2" - 11-1/2
1404-32-32	2" - 11-1/2	2" - 11-1/2

1405 ...PIPE SWIVEL UNION

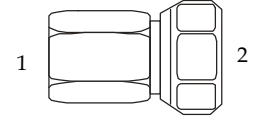

(1) (2)	FEMALE PIPE	FEMALE PIPE
1405-02-02	1/8" - 27	1/8" - 27
1405-02-04	1/8" - 27	1/4" - 18
1405-04-02	1/4" - 18	1/8" - 27
1405-04-04	1/4" - 18	1/4" - 18
1405-04-06	1/4" - 18	3/8" - 18
1405-04-08	1/4" - 18	1/2" - 14
1405-06-04	3/8" - 18	1/4" - 18
1405-06-06	3/8" - 18	3/8" - 18
1405-06-08	3/8" - 18	1/2" - 14
1405-08-04	1/2" - 14	1/4" - 18
1405-08-06	1/2" - 14	3/8" - 18
1405-08-08	1/2" - 14	1/2" - 14
1405-08-12	1/2" - 14	3/4" - 14
1405-12-06	3/4" - 14	3/8" - 18
1405-12-08	3/4" - 14	1/2" - 14
1405-12-12	3/4" - 14	3/4" - 14
1405-12-16	3/4" - 14	1" - 11-1/2
1405-16-12	1" - 11-1/2	3/4" - 14
1405-16-16	1" - 11-1/2	1" - 11-1/2
1405-20-20	1-1/4" - 11-1/2	1-1/4" - 11-1/2
1405-24-24	1-1/2" - 11-1/2	1-1/2" - 11-1/2
1405-32-32	2" - 11-1/2	2" - 11-1/2

PIPE THREAD

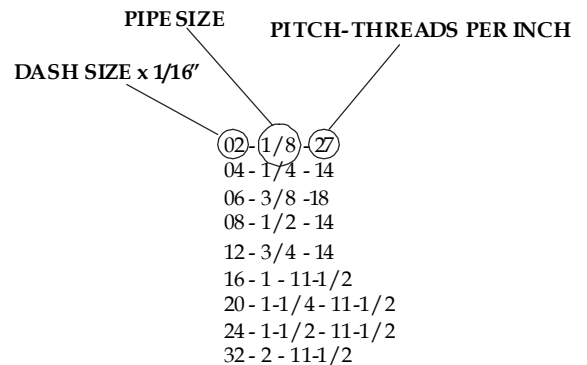

PIPE THREAD ADAPTERS

1501 ...PIPE SWIVEL 90° ELBOW

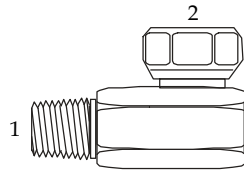

(1) (2)	MALE PIPE	FEMALE PIPE
1501-02-02	1/8" - 27	1/8" - 27
1501-02-04	1/8" - 27	1/4" - 18
1501-04-02	1/4" - 18	1/8" - 27
1501-04-04	1/4" - 18	1/4" - 18
1501-04-06	1/4" - 18	3/8" - 18
1501-04-08	1/4" - 18	1/2" - 14
1501-06-04	3/8" - 18	1/4" - 18
1501-06-06	3/8" - 18	3/8" - 18
1501-06-08	3/8" - 18	1/2" - 14
1501-06-12	3/8" - 18	3/4" - 14
1501-08-04	1/2" - 14	1/4" - 18
1501-08-06	1/2" - 14	3/8" - 18
1501-08-08	1/2" - 14	1/2" - 14
1501-08-12	1/2" - 14	3/4" - 14
1501-12-04	3/4" - 14	1/4" - 18
1501-12-06	3/4" - 14	3/8" - 18
1501-12-08	3/4" - 14	1/2" - 14
1501-12-12	3/4" - 14	3/4" - 14
1501-12-16	3/4" - 14	1" - 11-1/2
1501-12-20	3/4" - 14	1-1/4" - 11-1/2
1501-16-08	1" - 11-1/2	1/2" - 14
1501-16-12	1" - 11-1/2	3/4" - 14
1501-16-16	1" - 11-1/2	1" - 11-1/2
1501-16-20	1" - 11-1/2	1-1/4" - 11-1/2
1501-20-12	1-1/4" - 11-1/2	3/4" - 14
1501-20-16	1-1/4" - 11-1/2	1" - 11-1/2
1501-20-20	1-1/4" - 11-1/2	1-1/4" - 11-1/2
1501-20-24	1-1/4" - 11-1/2	1-1/2" - 11-1/2
1501-24-20	1-1/2" - 11-1/2	1-1/4" - 11-1/2
1501-24-24	1-1/2" - 11-1/2	1-1/2" - 11-1/2
1501-32-32	2" - 11-1/2	2" - 11-1/2

1502 ...PIPE SWIVEL 90° ELBOW

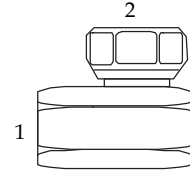

(1) (2)	FEMALE PIPE	FEMALE PIPE
1502-02-02	1/8" - 27	1/8" - 27
1502-02-04	1/8" - 27	1/4" - 18
1502-04-02	1/4" - 18	1/8" - 27
1502-04-04	1/4" - 18	1/4" - 18
1502-04-06	1/4" - 18	3/8" - 18
1502-06-04	3/8" - 18	1/4" - 18
1502-06-06	3/8" - 18	3/8" - 18
1502-06-08	3/8" - 18	1/2" - 14
1502-08-04	1/2" - 14	1/4" - 18
1502-08-06	1/2" - 14	3/8" - 18
1502-08-08	1/2" - 14	1/2" - 14
1502-08-12	1/2" - 14	3/4" - 14
1502-12-06	3/4" - 14	3/8" - 18
1502-12-08	3/4" - 14	1/2" - 14
1502-12-12	3/4" - 14	3/4" - 14
1502-12-16	3/4" - 14	1" - 11-1/2
1502-16-12	1" - 11-1/2	3/4" - 14
1502-16-16	1" - 11-1/2	1" - 11-1/2
1502-20-16	1-1/4" - 11-1/2	1" - 11-1/2
1502-20-20	1-1/4" - 11-1/2	1-1/4" - 11-1/2
1502-24-24	1-1/2" - 11-1/2	1-1/2" - 11-1/2
1502-32-32	2" - 11-1/2	2" - 11-1/2

1501 ...PIPE SWIVEL 90° ELBOW (LONG)

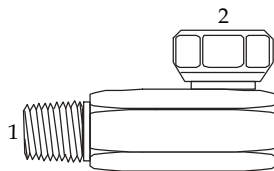

(1) (2)	MALE PIPE	FEMALE PIPE
1501-LL-02-02	1/8" - 27	1/8" - 27
1501-LL-04-04	1/4" - 18	1/4" - 18
1501-LL-06-06	3/8" - 18	3/8" - 18
1501-LL-08-08	1/2" - 14	1/2" - 14
1501-LL-12-12	3/4" - 14	3/4" - 14
1501-LL-16-16	1" - 11-1/2	1" - 11-1/2

PIPE THREAD

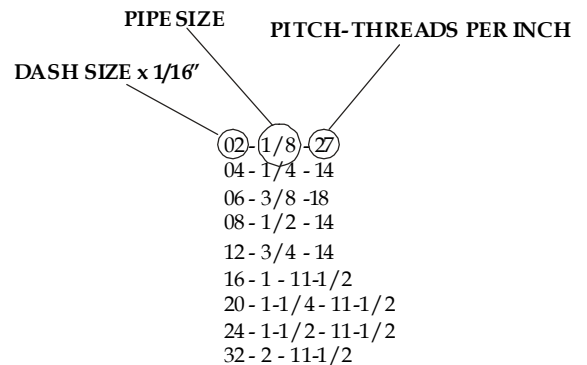

PIPE THREAD ADAPTERS

1503 ...PIPE SWIVEL 45° ELBOW

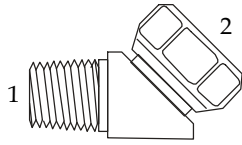

(1) (2)	MALE PIPE	FEMALE PIPE
1503-02-02	1/8" -27	1/8" -27
1503-02-04	1/8" -27	1/4" -18
1503-04-02	1/4" -18	1/8" -27
1503-04-04	1/4" -18	1/4" -18
1503-04-06	1/4" -18	3/8" -18
1503-04-08	1/4" -18	1/2" -14
1503-06-04	3/8" -18	1/4" -18
1503-06-06	3/8" -18	3/8" -18
1503-06-08	3/8" -18	1/2" -14
1503-08-04	1/2" -14	1/4" -18
1503-08-06	1/2" -14	3/8" -18
1503-08-08	1/2" -14	1/2" -14
1503-08-12	1/2" -14	3/4" -14
1503-12-06	3/4" -14	3/8" -18
1503-12-08	3/4" -14	1/2" -14
1503-12-12	3/4" -14	3/4" -14
1503-12-16	3/4" -14	1" -11-1/2
1503-16-12	1" - 11-1/2	3/4" -14
1503-16-16	1" - 11-1/2	1" - 11-1/2
1503-16-20	1" - 11-1/2	1-1/4" - 11-1/2
1503-20-16	1-1/4" - 11-1/2	1" - 11-1/2
1503-20-20	1-1/4" - 11-1/2	1-1/4" - 11-1/2
1503-24-24	1-1/2" - 11-1/2	1-1/2" - 11-1/2
1503-32-32	2" - 11-1/2	2" - 11-1/2

1504 ...PIPE SWIVEL 45° ELBOW

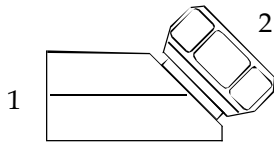

(1) (2)	FEMALE PIPE	FEMALE PIPE
1504-02-02	1/8" -27	1/8" -27
1504-02-04	1/8" -27	1/4" -18
1504-04-02	1/4" -18	1/8" -27
1504-04-04	1/4" -18	1/4" -18
1504-04-06	1/4" -18	3/8" -18
1504-06-04	3/8" -18	1/4" -18
1504-06-06	3/8" -18	3/8" -18
1504-06-08	3/8" -18	1/2" -14
1504-08-06	1/2" -14	3/8" -18
1504-08-08	1/2" -14	1/2" -14
1504-12-08	3/4" -14	1/2" -14
1504-12-12	3/4" -14	3/4" -14
1504-16-12	1" - 11-1/2	3/4" -14
1504-16-16	1" - 11-1/2	1" - 11-1/2
1504-20-20	1-1/4" - 11-1/2	1-1/4" - 11-1/2
1504-24-24	1-1/2" - 11-1/2	1-1/2" - 11-1/2
1504-32-32	2" - 11-1/2	2" - 11-1/2

1601 ...PIPE BRANCH TEE SWIVEL UNION

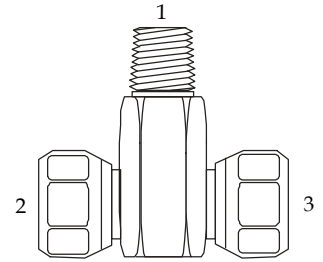

(1) (2) (3)	(1) MALE PIPE	(2)(3) FEMALE PIPE
1601-02-02-02	1/8" -27	1/8" -27
1601-04-04-04	1/4" -18	1/4" -18
1601-04-06-06	1/4" -18	3/8" -18
1601-06-04-04	3/8" -18	1/4" -18
1601-06-06-06	3/8" -18	3/8" -18
1601-06-08-08	3/8" -18	1/2" -14
1601-08-04-04	1/2" -14	1/4" -18
1601-08-06-06	1/2" -14	3/8" -18
1601-08-08-08	1/2" -14	1/2" -14
1601-12-08-08	3/4" -14	1/2" -14
1601-12-12-12	3/4" -14	3/4" -14
1601-16-16-16	1" - 11-1/2	1" - 11-1/2
1601-20-20-20	1-1/4" - 11-1/2	1-1/4" - 11-1/2
1601-24-24-24	1-1/2" - 11-1/2	1-1/2" - 11-1/2

1602 ...PIPE BRANCH TEE SWIVEL UNION

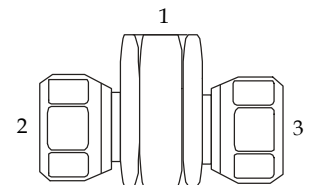

(1) (2) (3)	(1) FEMALE PIPE	(2)(3) FEMALE PIPE
1602-02-02-02	1/8" -27	1/8" -27
1602-04-04-04	1/4" -18	1/4" -18
1602-06-04-04	3/8" -18	1/4" -18
1602-06-06-06	3/8" -18	3/8" -18
1602-08-06-06	1/2" -14	3/8" -18
1602-08-08-08	1/2" -14	1/2" -14
1602-12-08-08	3/4" -14	1/2" -14
1602-12-12-12	3/4" -14	3/4" -14
1602-16-12-12	1" - 11-1/2	3/4" -14
1602-16-16-16	1" - 11-1/2	1" - 11-1/2
1602-20-20-20	1-1/4" - 11-1/2	1-1/4" - 11-1/2
1602-24-24-24	1-1/2" - 11-1/2	1-1/2" - 11-1/2

PIPE THREAD ADAPTERS

1603 ...FEMALE PIPE SWIVEL TEE

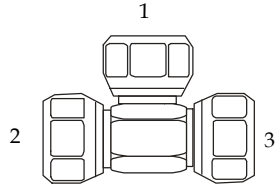

(1) (2) (3)	FEMALE PIPE
1603-02-02-02	1/8" - 27
1603-04-04-04	1/4" - 18
1603-06-06-06	3/8" - 18
1603-08-08-08	1/2" - 14
1603-12-12-12	3/4" - 14
1603-16-16-16	1" - 11-1/2
1603-20-20-20	1-1/4" - 11-1/2

5404 ...PIPE HEX NIPPLE

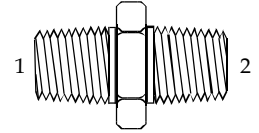

(1) (2)	MALE PIPE	MALE PIPE
5404-02-02	1/8" -27	1/8" -27
5404-04-02	1/4" -18	1/8" -27
5404-04-04	1/4" -18	1/4" -18
5404-06-02	3/8" -18	1/8" -27
5404-06-04	3/8" -18	1/4" -18
5404-06-06	3/8" -18	3/8" -18
5404-08-04	1/2" -14	1/4" -18
5404-08-06	1/2" -14	3/8" -18
5404-08-08	1/2" -14	1/2" -14
5404-12-04	3/4" -14	1/4" -18
5404-12-06	3/4" -14	3/8" -18
5404-12-08	3/4" -14	1/2" -14
5404-12-12	3/4" -14	3/4" -14
5404-16-08	1" -11-1/2	1/2" -14
5404-16-12	1" -11-1/2	3/4" -14
5404-16-16	1" -11-1/2	1" -11-1/2
5404-20-12	1-1/4" -11-1/2	3/4" -14
5404-20-16	1-1/4" -11-1/2	1" -11-1/2
5404-20-20	1-1/4" -11-1/2	1-1/4" -11-1/2
5404-24-12	1-1/2" -11-1/2	3/4" -14
5404-24-16	1-1/2" -11-1/2	1" -11-1/2
5404-24-20	1-1/2" -11-1/2	1-1/4" -11-1/2
5404-24-24	1-1/2" -11-1/2	1-1/2" -11-1/2
5404-32-24	2" -11-1/2	1-1/2" -11-1/2
5404-32-32	2" -11-1/2	2" -11-1/2

5000 ...PIPE COUPLING

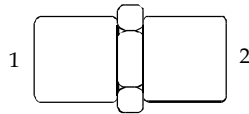

(1) (2)	FEMALE PIPE	FEMALE PIPE
5000-02-02	1/8" - 27	1/8" - 27
5000-04-02	1/4" - 18	1/8" - 27
5000-04-04	1/4" - 18	1/4" - 18
5000-06-02	3/8" - 18	1/8" - 27
5000-06-04	3/8" - 18	1/4" - 18
5000-06-06	3/8" - 18	3/8" - 18
5000-08-04	1/2" - 14	1/4" - 18
5000-08-06	1/2" - 14	3/8" - 18
5000-08-08	1/2" - 14	1/2" - 14
5000-12-06	3/4" - 14	3/8" - 18
5000-12-08	3/4" - 14	1/2" - 14
5000-12-12	3/4" - 14	3/4" - 14
5000-16-08	1" - 11-1/2	1/2" - 14
5000-16-12	1" - 11-1/2	3/4" - 14
5000-16-16	1" - 11-1/2	1" - 11-1/2
5000-20-16	1-1/4" - 11-1/2	1" - 11-1/2
5000-20-20	1-1/4" - 11-1/2	1-1/4" - 11-1/2
5000-24-20	1-1/2" - 11-1/2	1-1/4" - 11-1/2
5000-24-24	1-1/2" - 11-1/2	1-1/2" - 11-1/2
5000-24-32	1-1/2" - 11-1/2	2" - 11-1/2
5000-32-32	2" - 11-1/2	2" - 11-1/2

PIPE THREAD

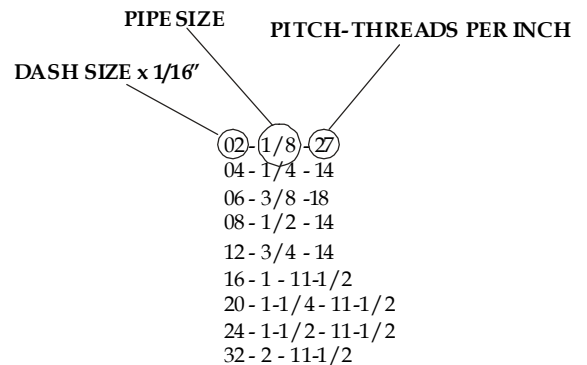

PIPE THREAD ADAPTERS

5405 ...PIPE EXPANDER/REDUCER

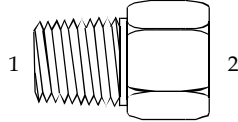

(1) (2)	MALE PIPE	FEMALE PIPE
5405-02-02	1/8" - 27	1/8" - 27
5405-02-04	1/8" - 27	1/4" - 18
5405-02-06	1/8" - 27	3/8" - 18
5405-02-08	1/8" - 27	1/2" - 14
5405-04-02	1/4" - 18	1/8" - 27
5405-04-04	1/4" - 18	1/4" - 18
5405-04-06	1/4" - 18	3/8" - 18
5405-04-08	1/4" - 18	1/2" - 14
5405-04-12	1/4" - 18	3/4" - 14
5405-06-04	3/8" - 18	1/4" - 18
5405-06-06	3/8" - 18	3/8" - 18
5405-06-08	3/8" - 18	1/2" - 14
5405-06-12	3/8" - 18	3/4" - 14
5405-08-04	1/2" - 14	1/4" - 18
5405-08-06	1/2" - 14	3/8" - 18
5405-08-08	1/2" - 14	1/2" - 14
5405-08-12	1/2" - 14	3/4" - 14
5405-08-16	1/2" - 14	1" - 11-1/2
5405-12-04	3/4" - 14	1/4" - 18
5405-12-06	3/4" - 14	3/8" - 18
5405-12-08	3/4" - 14	1/2" - 14
5405-12-12	3/4" - 14	3/4" - 14
5405-12-16	3/4" - 14	1" - 11-1/2
5405-12-20	3/4" - 14	1-1/4" - 11-1/2
5405-16-08	1" - 11-1/2	1/2" - 14
5405-16-12	1" - 11-1/2	3/4" - 14
5405-16-16	1" - 11-1/2	1" - 11-1/2
5405-16-20	1" - 11-1/2	1-1/4" - 11-1/2
5405-16-24	1" - 11-1/2	1-1/2" - 11-1/2
5405-20-12	1-1/4" - 11-1/2	3/4" - 14
5405-20-16	1-1/4" - 11-1/2	1" - 11-1/2
5405-20-20	1-1/4" - 11-1/2	1-1/4" - 11-1/2
5405-20-24	1-1/4" - 11-1/2	1-1/2" - 11-1/2
5405-20-32	1-1/4" - 11-1/2	2" - 11-1/2
5405-24-20	1-1/2" - 11-1/2	1-1/4" - 11-1/2
5405-24-24	1-1/2" - 11-1/2	1-1/2" - 11-1/2
5405-24-32	1-1/2" - 11-1/2	2" - 11-1/2
5405-32-32	2" - 11-1/2	2" - 11-1/2

5406 ...HEX REDUCER BUSHING

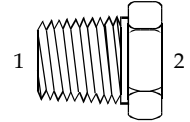

(1) (2)	MALE PIPE	FEMALE PIPE
5406-04-02	1/4" - 18	1/8" - 27
5406-06-02	3/8" - 18	1/8" - 27
5406-06-04	3/8" - 18	1/4" - 18
5406-08-02	1/2" - 14	1/8" - 27
5406-08-04	1/2" - 14	1/4" - 18
5406-08-06	1/2" - 14	3/8" - 18
5406-12-02	3/4" - 14	1/8" - 27
5406-12-04	3/4" - 14	1/4" - 18
5406-12-06	3/4" - 14	3/8" - 18
5406-12-08	3/4" - 14	1/2" - 14
5406-16-02	1" - 11-1/2	1/8" - 27
5406-16-04	1" - 11-1/2	1/4" - 18
5406-16-06	1" - 11-1/2	3/8" - 18
5406-16-08	1" - 11-1/2	1/2" - 14
5406-16-12	1" - 11-1/2	3/4" - 14
5406-20-04	1-1/4" - 11-1/2	1/4" - 18
5406-20-06	1-1/4" - 11-1/2	3/8" - 18
5406-20-08	1-1/4" - 11-1/2	1/2" - 14
5406-20-12	1-1/4" - 11-1/2	3/4" - 14
5406-20-16	1-1/4" - 11-1/2	1" - 11-1/2
5406-24-04	1-1/2" - 11-1/2	1/4" - 18
5406-24-06	1-1/2" - 11-1/2	3/8" - 18
5406-24-08	1-1/2" - 11-1/2	1/2" - 14
5406-24-12	1-1/2" - 11-1/2	3/4" - 14
5406-24-16	1-1/2" - 11-1/2	1" - 11-1/2
5406-24-20	1-1/2" - 11-1/2	1-1/4" - 11-1/2
5406-32-08	2" - 11-1/2	1/2" - 14
5406-32-12	2" - 11-1/2	3/4" - 14
5406-32-16	2" - 11-1/2	1" - 11-1/2
5406-32-20	2" - 11-1/2	1-1/4" - 11-1/2
5406-32-24	2" - 11-1/2	1-1/2" - 11-1/2

5406 C ...STEEL PIPE CAP

	FEMALE PIPE
5406-C-02	1/8" - 27
5406-C-04	1/4" - 18
5406-C-06	3/8" - 18
5406-C-08	1/2" - 14
5406-C-12	3/4" - 14
5406-C-16	1" - 11-1/2
5406-C-20	1-1/4" - 11-1/2

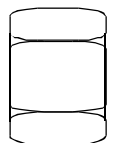

PIPE THREAD ADAPTERS

5406 P ...STEEL PIPE PLUG

	MALE PIPE
5406-P-02	1/8" -27
5406-P-04	1/4" -18
5406-P-06	3/8" -18
5406-P-08	1/2" -14
5406-P-12	3/4" -14
5406-P-16	1" -11-1/2
5406-P-20	1-1/4" -11-1/2
5406-P-24	1-1/2" -11-1/2
5406-P-32	2" -11-1/2

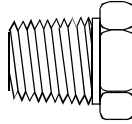

5500 ...MALE PIPE 90° ELBOW

(1) (2)	MALE PIPE	MALE PIPE
5500-02-02	1/8" - 27	1/8" - 27
5500-04-02	1/4" - 18	1/8" - 27
5500-04-04	1/4" - 18	1/4" - 18
5500-06-04	3/8" - 18	1/4" - 18
5500-06-06	3/8" - 18	3/8" - 18
5500-08-04	1/2" - 14	1/4" - 18
5500-08-06	1/2" - 14	3/8" - 18
5500-08-08	1/2" - 14	1/2" - 14
5500-12-08	3/4" - 14	1/2" - 14
5500-12-12	3/4" - 14	3/4" - 14
5500-16-08	1" - 11-1/2	1/2" - 14
5500-16-12	1" - 11-1/2	3/4" - 14
5500-16-16	1" - 11-1/2	1" - 11-1/2
5500-20-20	1-1/4" - 11-1/2	1-1/4" - 11-1/2
5500-24-24	1-1/2" - 11-1/2	1-1/2" - 11-1/2

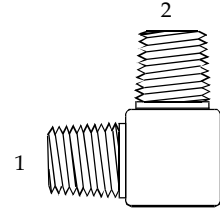

5406 HP ...HOLLOW HEX PIPE PLUG

	MALE PIPE
5406-HP-01	1/16" -27
5406-HP-02	1/8" -27
5406-HP-04	1/4" -18
5406-HP-06	3/8" -18
5406-HP-08	1/2" -14
5406-HP-12	3/4" -14
5406-HP-16	1" -11-1/2
5406-HP-20	1-1/4" -11-1/2
5406-HP-24	1-1/2" -11-1/2
5406-HP-32	2" -11-1/2

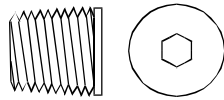

5501 ...MALE PIPE 45° ELBOW

(1) (2)	MALE PIPE	MALE PIPE
5501-02-02	1/8" - 27	1/8" - 27
5501-04-04	1/4" - 18	1/4" - 18
5501-06-06	3/8" - 18	3/8" - 18
5501-08-08	1/2" - 14	1/2" - 14
5501-12-12	3/4" - 14	3/4" - 14
5501-16-16	1" - 11-1/2	1" - 11-1/2
5501-20-20	1-1/4" - 11-1/2	1-1/4" - 11-1/2
5501-24-24	1-1/2" - 11-1/2	1-1/2" - 11-1/2
5501-32-32	2" - 11-1/2	2" - 11-1/2

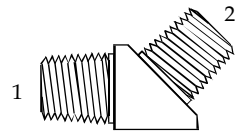

5406 SHP ...SQUARE HEAD PIPE PLUG

	MALE PIPE
5406-SHP-02	1/8" -27
5406-SHP-04	1/4" -18
5406-SHP-06	3/8" -18
5406-SHP-08	1/2" -14
5406-SHP-12	3/4" -14
5406-SHP-16	1" -11-1/2

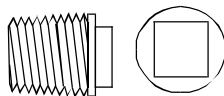

PIPE THREAD ADAPTERS

5502 ..PIPE 90° STREET ELBOW

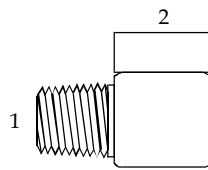

(1) (2)	MALE PIPE	FEMALE PIPE
5502-02-02	1/8" - 27	1/8" - 27
5502-02-04	1/8" - 27	1/4" - 18
5502-02-06	1/8" - 27	3/8" - 18
5502-04-02	1/4" - 18	1/8" - 27
5502-04-04	1/4" - 18	1/4" - 18
5502-04-06	1/4" - 18	3/8" - 18
5502-04-08	1/4" - 18	1/2" - 14
5502-06-02	3/8" - 18	1/8" - 27
5502-06-04	3/8" - 18	1/4" - 18
5502-06-06	3/8" - 18	3/8" - 18
5502-06-08	3/8" - 18	1/2" - 14
5502-08-04	1/2" - 14	1/4" - 18
5502-08-06	1/2" - 14	3/8" - 18
5502-08-08	1/2" - 14	1/2" - 14
5502-08-12	1/2" - 14	3/4" - 14
5502-12-06	3/4" - 14	3/8" - 18
5502-12-08	3/4" - 14	1/2" - 14
5502-12-12	3/4" - 14	3/4" - 14
5502-12-16	3/4" - 14	1" - 11-1/2
5502-16-12	1" - 11-1/2	3/4" - 14
5502-16-16	1" - 11-1/2	1" - 11-1/2
5502-16-20	1" - 11-1/2	1-1/4" - 11-1/2
5502-20-16	1-1/4" - 11-1/2	1" - 11-1/2
5502-20-20	1-1/4" - 11-1/2	1-1/4" - 11-1/2
5502-20-24	1-1/4" - 11-1/2	1-1/2" - 11-1/2
5502-24-20	1-1/2" - 11-1/2	1-1/4" - 11-1/2
5502-24-24	1-1/2" - 11-1/2	1-1/2" - 11-1/2
5502-32-32	2" - 11-1/2	2" - 11-1/2

5503 ...PIPE 45° STREET ELBOW

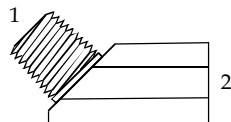

(1) (2)	MALE PIPE	FEMALE PIPE
5503-02-02	1/8" - 27	1/8" - 27
5503-04-04	1/4" - 18	1/4" - 18
5503-06-06	3/8" - 18	3/8" - 18
5503-08-08	1/2" - 14	1/2" - 14
5503-12-12	3/4" - 14	3/4" - 14
5503-16-16	1" - 11-1/2	1" - 11-1/2
5503-20-20	1-1/4" - 11-1/2	1-1/4" - 11-1/2
5503-24-24	1-1/2" - 11-1/2	1-1/2" - 11-1/2

5504 ...PIPE 90° ELBOW

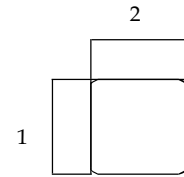

(1) (2)	FEMALE PIPE	FEMALE PIPE
5504-02-02	1/8" - 27	1/8" - 27
5504-04-02	1/4" - 18	1/8" - 27
5504-04-04	1/4" - 18	1/4" - 18
5504-06-04	3/8" - 18	1/4" - 18
5504-06-06	3/8" - 18	3/8" - 18
5504-08-04	1/2" - 14	1/4" - 18
5504-08-06	1/2" - 14	3/8" - 18
5504-08-08	1/2" - 14	1/2" - 14
5504-12-06	3/4" - 14	3/8" - 18
5504-12-08	3/4" - 14	1/2" - 14
5504-12-12	3/4" - 14	3/4" - 14
5504-16-08	1" - 11-1/2	1/2" - 14
5504-16-12	1" - 11-1/2	3/4" - 14
5504-16-16	1" - 11-1/2	1" - 11-1/2
5504-20-12	1-1/4" - 11-1/2	3/4" - 14
5504-20-16	1-1/4" - 11-1/2	1" - 11-1/2
5504-20-20	1-1/4" - 11-1/2	1-1/4" - 11-1/2
5504-24-20	1-1/2" - 11-1/2	1-1/4" - 11-1/2
5504-24-24	1-1/2" - 11-1/2	1-1/2" - 11-1/2
5504-32-32	2" - 11-1/2	2" - 11-1/2

5505 ...PIPE 45° ELBOW

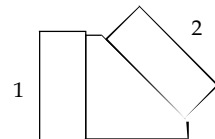

(1) (2)	FEMALE PIPE	FEMALE PIPE
5505-02-02	1/8" - 27	1/8" - 27
5505-04-04	1/4" - 18	1/4" - 18
5505-06-06	3/8" - 18	3/8" - 18
5505-08-08	1/2" - 14	1/2" - 14
5505-12-12	3/4" - 14	3/4" - 14
5505-16-16	1" - 11-1/2	1" - 11-1/2
5505-20-20	1-1/4" - 11-1/2	1-1/4" - 11-1/2

PIPE THREAD ADAPTERS

5600 ...MALE PIPE TEE

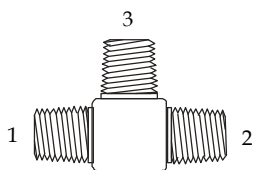

(1) (2) (3)	MALE PIPE
5600-02-02-02	1/8" - 27
5600-04-04-04	1/4" - 18
5600-06-06-06	3/8" - 18
5600-08-08-08	1/2" - 14
5600-12-12-12	3/4" - 14
5600-16-16-16	1" - 11-1/2

5603 ...PIPE TEE

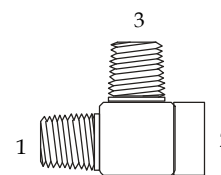

(1) (2) (3)	(1) (3) MALE PIPE	(2) FEMALE PIPE
560B-02-02-02	1/8" - 27	1/8" - 27
560B-04-04-04	1/4" - 18	1/4" - 18
560B-06-06-06	3/8" - 18	3/8" - 18
560B-08-08-08	1/2" - 14	1/2" - 14
560B-12-12-12	3/4" - 14	3/4" - 14
560B-16-16-16	1" - 11-1/2	1" - 11-1/2
560B-20-20-20	1-1/4" - 11-1/2	1-1/4" - 11-1/2
560B-24-24-24	1-1/2" - 11-1/2	1-1/2" - 11-1/2
560B-32-32-32	2" - 11-1/2	2" - 11-1/2

5601 ...PIPE TEE

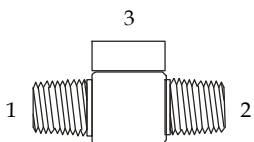

(1) (2) (3)	(1) (2) MALE PIPE	(3) FEMALE PIPE
5601-02-02-02	1/8" - 27	1/8" - 27
5601-04-04-04	1/4" - 18	1/4" - 18
5601-06-06-06	3/8" - 18	3/8" - 18
5601-08-08-08	1/2" - 14	1/2" - 14
5601-12-12-12	3/4" - 14	3/4" - 14
5601-16-16-16	1" - 11-1/2	1" - 11-1/2
5601-20-20-20	1-1/4" - 11-1/2	1-1/4" - 11-1/2
5601-24-24-24	1-1/2" - 11-1/2	1-1/2" - 11-1/2

5604 ...PIPE BRANCH TEE

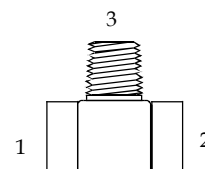

(1) (2) (3)	(1) (2) FEMALE PIPE	(3) MALE PIPE
5604-02-02-02	1/8" - 27	1/8" - 27
5604-04-04-04	1/4" - 18	1/4" - 18
5604-06-06-06	3/8" - 18	3/8" - 18
5604-08-08-08	1/2" - 14	1/2" - 14
5604-12-12-08	3/4" - 14	1/2" - 14
5604-12-12-12	3/4" - 14	3/4" - 14
5604-16-16-16	1" - 11-1/2	1" - 11-1/2
5604-20-20-20	1-1/4" - 11-1/2	1-1/4" - 11-1/2
5604-24-24-24	1-1/2" - 11-1/2	1-1/2" - 11-1/2
5604-32-32-32	2" - 11-1/2	2" - 11-1/2

5602 ...PIPE THREAD RUN TEE

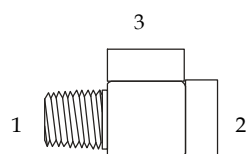

(1) (2) (3)	(1) MALE PIPE	(2) (3) FEMALE PIPE
5602-02-02-02	1/8" - 27	1/8" - 27
5602-02-04-04	1/8" - 27	1/4" - 18
5602-04-04-04	1/4" - 18	1/4" - 18
5602-06-06-06	3/8" - 18	3/8" - 18
5602-08-08-08	1/2" - 14	1/2" - 14
5602-12-12-12	3/4" - 14	3/4" - 14
5602-16-16-16	1" - 11-1/2	1" - 11-1/2
5602-20-20-20	1-1/4" - 11-1/2	1-1/4" - 11-1/2
5602-24-24-24	1-1/2" - 11-1/2	1-1/2" - 11-1/2
5602-32-32-32	2" - 11-1/2	2" - 11-1/2

5605 ...PIPE TEE

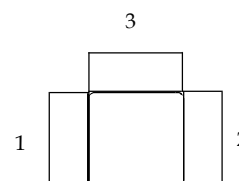

(1) (2) (3)	(1) (2) FEMALE PIPE	(3) FEMALE PIPE
5605-02-02-02	1/8" - 27	1/8" - 27
5605-04-04-02	1/4" - 18	1/8" - 27
5605-04-04-04	1/4" - 18	1/4" - 18
5605-06-06-06	3/8" - 18	3/8" - 18
5605-06-06-08	3/8" - 18	1/2" - 14
5605-08-08-08	1/2" - 14	1/2" - 14
5605-12-12-12	3/4" - 14	3/4" - 14
5605-16-16-16	1" - 11-1/2	1" - 11-1/2
5605-20-20-20	1-1/4" - 11-1/2	1-1/4" - 11-1/2
5605-24-24-24	1-1/2" - 11-1/2	1-1/2" - 11-1/2
5605-32-32-32	2" - 11-1/2	2" - 11-1/2

PIPE THREAD ADAPTERS

5652 ...PIPE CROSS

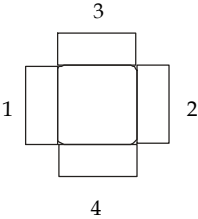

- (1) (2) (3) (4)
- 5652-02-02-02-02
- 5652-04-04-04-04
- 5652-06-06-06-06
- 5652-08-08-08-08
- 5652-12-12-12-12
- 5652-16-16-16-16
- 5652-20-20-20-20
- 5652-24-24-24-24
- 5652-32-32-32-32

- FEMALE PIPE
- 1/8" - 27
 - 1/4" - 18
 - 3/8" - 18
 - 1/2" - 14
 - 3/4" - 14
 - 1" - 11-1/2
 - 1-1/4" - 11-1/2
 - 1-1/2" - 11-1/2
 - 2" - 11-1/2

JIC 37° FLARE ADAPTERS - QUICK VIEW

Detailed Sizes on the following pages.

304 C

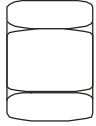

JIC CAP

306

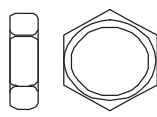

BULKHEAD
LOCKNUT

318

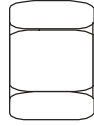

TUBE NUT

319

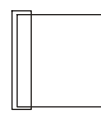

TUBE SLEEVE

2403

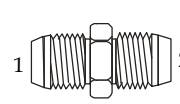

(1)(2) MALE JIC

2404

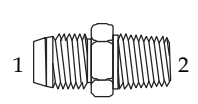

(1) MALE JIC
(2) MALE NPT

2405

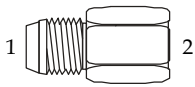

(1) Male JIC
(2) Female NPT

2406

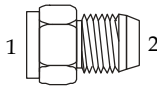

(1) Female JIC
(2) Male JIC

2408

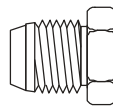

JIC Plug

2500

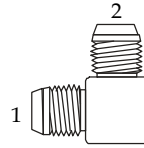

(1) Male JIC
(2) Male JIC

2501

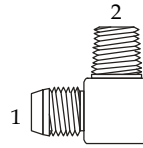

(1) Male JIC
(2) Male NPT

2501L

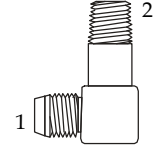

(1) Male JIC
(2) Male NPT Long

2501LL

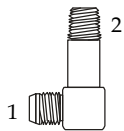

(1) Male JIC
(2) NPT Extra Long

2502

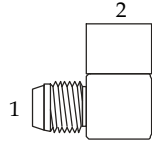

(1) Male JIC
(2) Female NPT

2503

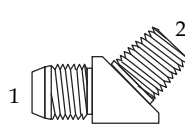

(1) Male JIC
(2) Male NPT

2504

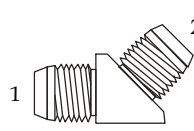

(1) Male JIC
(2) Male JIC

2505

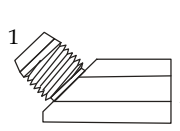

(1) Male JIC
(2) Female NPT

2601

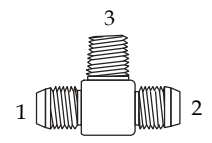

(1) (2) Male JIC
(2) Male NPT

2602

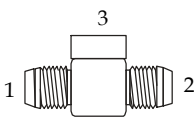

(1) (2) Male JIC
(2) Female NPT

2603

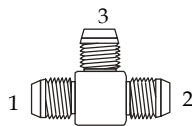

(1)(2)(3) Male JIC

2605

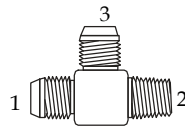

(1)(3) Male JIC
(2) Male NPT

2606

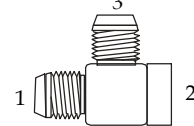

(1)(3) Male JIC
(2) Female NPT

2650

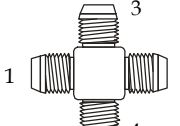

(1)(2)(3)(4) Male JIC

2700

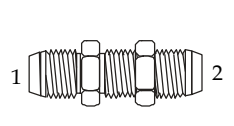

(1) Male JIC
(2) JIC Bulkhead

2701



(1) Male JIC
(2) JIC Bulkhead

2702

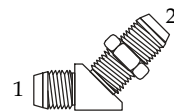

(1) Male JIC
(2) JIC Bulkhead

2703

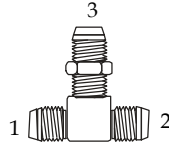

(1)(2) Male JIC
(3) JIC Bulkhead

2704

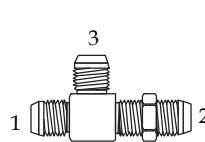

(1)(3) Male JIC
(2) JIC Bulkhead

2705

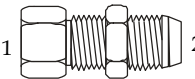

(1) Female NPT
(2) JIC Bulkhead

2706

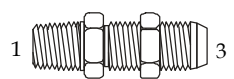

(1) Male NPT
(2) JIC Bulkhead

6400

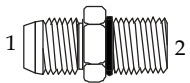

(1) Male JIC
(2) Male ORB

6400-L

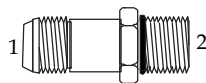

(1) Male JIC
(2) Male ORB Long

JIC 37° FLARE ADAPTERS - QUICK VIEW

Detailed Sizes on the following pages.

6500

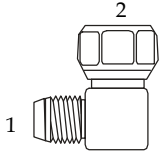

(1) Male JIC
(2) Female JIC

6500-L

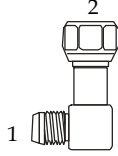

(1) Male JIC
(2) Female JIC Long

6501

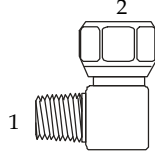

(1) Male NPT
(2) Female JIC

6502

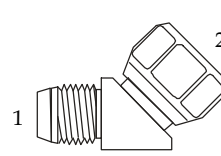

(1) Male JIC
(2) Female JIC

6503

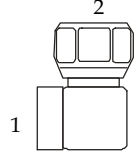

(1) Female NPT
(2) Female JIC

6504

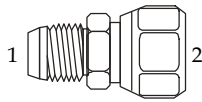

(1) Male JIC
(2) Female JIC

6505

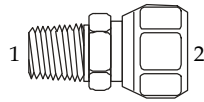

(1) Male NPT
(2) Female JIC

6506

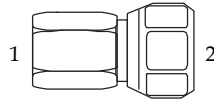

(1) Female NPT
(2) Female JIC

6565

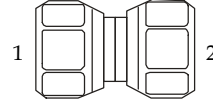

(1) Female JIC
(2) Female JIC

6600

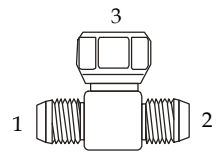

(1)(2) Male JIC
(3) Female JIC

6602

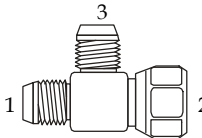

(1)(3) Male JIC
(2) Female JIC

6603

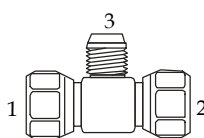

(1)(2) Female JIC
(3) Male JIC

6606

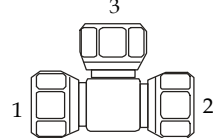

(1)(2)(3) Female JIC

6701

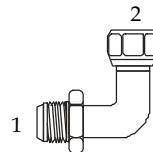

(1) Male JIC
(2) Female JIC

6701-L

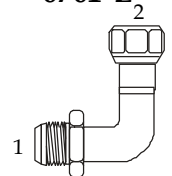

(1) Male JIC
(2) Female JIC Long

6801

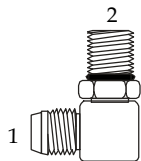

(1) Male JIC
(2) Male ORB

6801-L

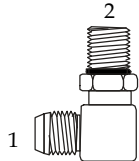

(1) Male JIC
(2) Male ORB

6801-LL

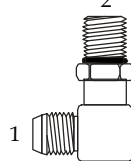

(1) Male JIC
(2) Male ORB X Long

6801-LLL

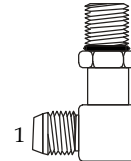

(1) Male JIC
(2) Male ORB XXL Long

6802

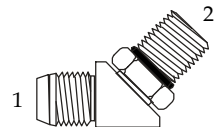

(1) Male JIC
(2) Male ORB

6803

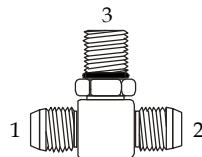

(1)(2) Male JIC
(3) Male ORB

6804

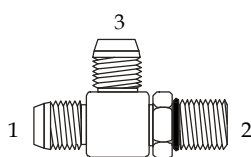

(1)(3) Male JIC
(2) Male ORB

6809

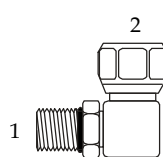

(1) Male ORB
(2) Female JIC

JIC 37° FLARE ADAPTERS

304C ...JIC CAP

	FEMALE JIC
304C-02	5/16 - 24
304C-03	3/8 - 24
304C-04	7/16 - 20
304C-05	1/2 - 20
304C-06	9/16 - 18
304C-08	3/4 - 16
304C-10	7/8 - 14
304C-12	1-1/16 - 12
304C-14	1-3/16 - 12
304C-16	1-5/16 - 12
304C-20	1-5/8 - 12
304C-24	1-7/8 - 12
304C-32	2-1/2 - 12

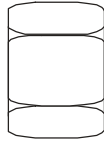

319 ...JIC TUBE SLEEVE

	TUBE O.D.
319-02	1/8"
319-03	3/16"
319-04	1/4"
319-05	5/16"
319-06	3/8"
319-08	1/2"
319-10	5/8"
319-12	3/4"
319-14	7/8"
319-16	1"
319-20	1-1/4"
319-24	1-1/2"
319-32	2"

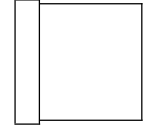

306 ...JIC BULHHEAD LOCKNUT

	THREAD
306-02	5/16 - 24
306-03	3/8 - 24
306-04	7/16 - 20
306-05	1/2 - 20
306-06	9/16 - 18
306-08	3/4 - 16
306-10	7/8 - 14
306-12	1-1/16 - 12
306-14	1-3/16 - 12
306-16	1-5/16 - 12
306-20	1-5/8 - 12
306-24	1-7/8 - 12
306-32	2-1/2 - 12

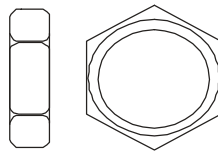

0403 ...JIC WELD ADAPTER

(1) (2)	MALE JIC	SOCKET I.D.
0403-04-04	7/16 - 20	1/4"
0403-05-04	1/2 - 20	1/4"
0403-05-05	1/2 - 20	5/16"
0403-06-06	9/16 - 18	3/8"
0403-06-08	9/16 - 18	1/2"
0403-08-06	3/4 - 16	3/8"
0403-08-08	3/4 - 16	1/2"
0403-08-10	3/4 - 16	5/8"
0403-10-08	7/8 - 14	1/2"
0403-10-10	7/8 - 14	5/8"
0403-10-12	7/8 - 14	3/4"
0403-12-08	1-1/16 - 12	1/2"
0403-12-10	1-1/16 - 12	5/8"
0403-12-12	1-1/16 - 12	3/4"
0403-14-14	1-3/16 - 12	7/8"
0403-16-12	1-5/16 - 12	3/4"
0403-16-16	1-5/16 - 12	1"
0403-16-20	1-5/16 - 12	1-1/4"
0403-20-16	1-5/8 - 12	1"
0403-20-20	1-5/8 - 12	1-1/4"
0403-20-24	1-5/8 - 12	1-1/2"
0403-24-20	1-7/8 - 12	1-1/4"
0403-24-24	1-7/8 - 12	1-1/2"
0403-32-32	2-1/2 - 12	2"

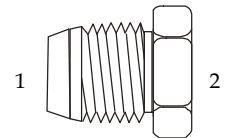

318 ...JIC TUBE NUT

	THREAD	TUBE O.D.
318-02	5/16 - 24	1/8"
318-03	3/8 - 24	3/16"
318-04	7/16 - 20	1/4"
318-05	1/2 - 20	5/16"
318-06	9/16 - 18	3/8"
318-08	3/4 - 16	1/2"
318-10	7/8 - 14	5/8"
318-12	1-1/16 - 12	3/4"
318-14	1-3/16 - 12	7/8"
318-16	1-5/16 - 12	1"
318-20	1-5/8 - 12	1-1/4"
318-24	1-7/8 - 12	1-1/2"
318-32	2-1/2 - 12	2"

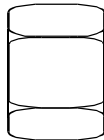

JIC 37° FLARE ADAPTERS

2403 ...JIC UNION

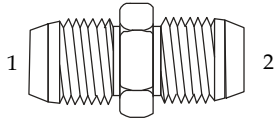

(1) (2)	MALE JIC	MALE JIC
2403-02-02	5/16 - 24	5/16 - 24
2403-03-02	3/8 - 24	5/16 - 24
2403-03-03	3/8 - 24	3/8 - 24
2403-04-02	7/16 - 20	5/16 - 24
2403-04-03	7/16 - 20	3/8 - 24
2403-04-04	7/16 - 20	7/16 - 20
2403-05-04	1/2 - 20	7/16 - 20
2403-05-05	1/2 - 20	1/2 - 20
2403-06-04	9/16 - 18	7/16 - 20
2403-06-05	9/16 - 18	1/2 - 20
2403-06-06	9/16 - 18	9/16 - 18
2403-08-04	3/4 - 16	7/16 - 20
2403-08-05	3/4 - 16	1/2 - 20
2403-08-06	3/4 - 16	9/16 - 18
2403-08-08	3/4 - 16	3/4 - 16
2403-10-04	7/8 - 14	7/16 - 20
2403-10-05	7/8 - 14	1/2 - 20
2403-10-06	7/8 - 14	9/16 - 18
2403-10-08	7/8 - 14	3/4 - 16
2403-10-10	7/8 - 14	7/8 - 14
2403-12-04	1-1/16 - 12	7/16 - 20
2403-12-06	1-1/16 - 12	9/16 - 18
2403-12-08	1-1/16 - 12	3/4 - 16
2403-12-10	1-1/16 - 12	7/8 - 14
2403-12-12	1-1/16 - 12	1-1/16 - 12
2403-14-12	1-3/16 - 12	1-1/16 - 12
2403-14-14	1-3/16 - 12	1-3/16 - 12
2403-16-06	1-5/16 - 12	9/16 - 18
2403-16-08	1-5/16 - 12	3/4 - 16
2403-16-10	1-5/16 - 12	7/8 - 14
2403-16-12	1-5/16 - 12	1-1/16 - 12
2403-16-14	1-5/16 - 12	1-3/16 - 12
2403-16-16	1-5/16 - 12	1-5/16 - 12
2403-20-12	1-5/8 - 12	1-1/16 - 12
2403-20-16	1-5/8 - 12	1-5/16 - 12
2403-20-20	1-5/8 - 12	1-5/8 - 12
2403-24-12	1-7/8 - 12	1-1/16 - 12
2403-24-16	1-7/8 - 12	1-5/16 - 12
2403-24-20	1-7/8 - 12	1-5/8 - 12
2403-24-24	1-7/8 - 12	1-7/8 - 12
2403-32-16	2-1/2 - 12	1-5/16 - 12
2403-32-20	2-1/2 - 12	1-5/8 - 12
2403-32-24	2-1/2 - 12	1-7/8 - 12
2403-32-32	2-1/2 - 12	2-1/2 - 12

2404 ...JIC 37° - PIPE UNION

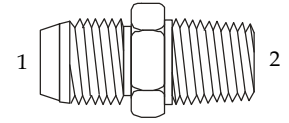

(1) (2)	MALE JIC	MALE PIPE
2404-02-02	5/16 - 24	1/8" - 27
2404-02-04	5/16 - 24	1/4" - 18
2404-03-02	3/8 - 24	1/8" - 27
2404-03-04	3/8 - 24	1/4" - 18
2404-04-02	7/16 - 20	1/8" - 27
2404-04-04	7/16 - 20	1/4" - 18
2404-04-06	7/16 - 20	3/8" - 18
2404-04-08	7/16 - 20	1/2" - 14
2404-04-12	7/16 - 20	3/4" - 14
2404-05-02	1/2 - 20	1/8" - 27
2404-05-04	1/2 - 20	1/4" - 18
2404-05-06	1/2 - 20	3/8" - 18
2404-05-08	1/2 - 20	1/2" - 14
2404-06-02	9/16 - 18	1/8" - 27
2404-06-04	9/16 - 18	1/4" - 18
2404-06-06	9/16 - 18	3/8" - 18
2404-06-08	9/16 - 18	1/2" - 14
2404-06-12	9/16 - 18	3/4" - 14
2404-08-02	3/4 - 16	1/8" - 27
2404-08-04	3/4 - 16	1/4" - 18
2404-08-06	3/4 - 16	3/8" - 18
2404-08-08	3/4 - 16	1/2" - 14
2404-08-12	3/4 - 16	3/4" - 14
2404-08-16	3/4 - 16	1" - 11-1/2
2404-10-04	7/8 - 14	1/4" - 18
2404-10-06	7/8 - 14	3/8" - 18
2404-10-08	7/8 - 14	1/2" - 14
2404-10-12	7/8 - 14	3/4" - 14
2404-10-16	7/8 - 14	1" - 11-1/2
2404-12-06	1-1/16 - 12	3/8" - 18
2404-12-08	1-1/16 - 12	1/2" - 14
2404-12-12	1-1/16 - 12	3/4" - 14
2404-12-16	1-1/16 - 12	1" - 11-1/2
2404-12-20	1-1/16 - 12	1-1/4" - 11-1/2
2404-12-24	1-1/16 - 12	1-1/2" - 11-1/2
2404-14-08	1-3/16 - 12	1/2" - 14
2404-14-12	1-3/16 - 12	3/4" - 14
2404-14-16	1-3/16 - 12	1" - 11-1/2
2404-16-08	1-5/16 - 12	1/2" - 14
2404-16-12	1-5/16 - 12	3/4" - 14
2404-16-16	1-5/16 - 12	1" - 11-1/2
2404-16-20	1-5/16 - 12	1-1/4" - 11-1/2
2404-16-24	1-5/16 - 12	1-1/2" - 11-1/2
2404-20-12	1-5/8 - 12	3/4" - 14
2404-20-16	1-5/8 - 12	1" - 11-1/2
2404-20-20	1-5/8 - 12	1-1/4" - 11-1/2
2404-20-24	1-5/8 - 12	1-1/2" - 11-1/2
2404-20-32	1-5/8 - 12	2" - 11-1/2
2404-24-12	1-7/8 - 12	3/4" - 14
2404-24-16	1-7/8 - 12	1" - 11-1/2
2404-24-20	1-7/8 - 12	1-1/4" - 11-1/2
2404-24-24	1-7/8 - 12	1-1/2" - 11-1/2
2404-24-32	1-7/8 - 12	2" - 11-1/2
2404-32-12	2-1/2 - 12	3/4" - 14
2404-32-16	2-1/2 - 12	1" - 11-1/2
2404-32-20	2-1/2 - 12	1-1/4" - 11-1/2
2404-32-24	2-1/2 - 12	1-1/2" - 11-1/2
2404-32-32	2-1/2 - 12	2" - 11-1/2

JIC 37° FLARE ADAPTERS

2405 ...JIC - FEMALE PIPE

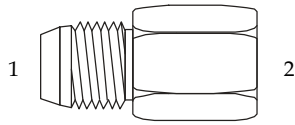

(1) (2)	MALE JIC	FEMALE PIPE
2405-02-02	5/16 - 24	1/8" - 27
2405-03-02	3/8 - 24	1/8" - 27
2405-03-04	3/8 - 24	1/4" - 18
2405-04-02	7/16 - 20	1/8" - 27
2405-04-04	7/16 - 20	1/4" - 18
2405-04-06	7/16 - 20	3/8" - 18
2405-04-08	7/16 - 20	1/2" - 14
2405-05-02	1/2 - 20	1/8" - 27
2405-05-04	1/2 - 20	1/4" - 18
2405-06-02	9/16 - 18	1/8" - 27
2405-06-04	9/16 - 18	1/4" - 18
2405-06-06	9/16 - 18	3/8" - 18
2405-06-08	9/16 - 18	1/2" - 14
2405-08-04	3/4 - 16	1/4" - 18
2405-08-06	3/4 - 16	3/8" - 18
2405-08-08	3/4 - 16	1/2" - 14
2405-08-12	3/4 - 16	3/4" - 14
2405-10-06	7/8 - 14	3/8" - 18
2405-10-08	7/8 - 14	1/2" - 14
2405-10-12	7/8 - 14	3/4" - 14
2405-12-08	1-1/16 - 12	1/2" - 14
2405-12-12	1-1/16 - 12	3/4" - 14
2405-12-16	1-1/16 - 12	1" - 11-1/2
2405-14-12	1-3/16 - 12	3/4" - 14
2405-16-12	1-5/16 - 12	3/4" - 14
2405-16-16	1-5/16 - 12	1" - 11-1/2
2405-16-20	1-5/16 - 12	1-1/4" - 11-1/2
2405-20-16	1-5/8 - 12	1" - 11-1/2
2405-20-20	1-5/8 - 12	1-1/4" - 11-1/2
2405-20-24	1-5/8 - 12	1-1/2" - 11-1/2
2405-24-20	1-7/8 - 12	1-1/4" - 11-1/2
2405-24-24	1-7/8 - 12	1-1/2" - 11-1/2
2405-32-32	2-1/2 - 12	2" - 11-1/2

2406 ...JIC REDUCER/ EXPANDER

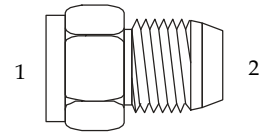

(1) (2)	FEMALE JIC	MALE JIC
2406-03-04	3/8 - 24	7/16 - 20
2406-04-03	7/16 - 20	3/8 - 24
2406-04-06	7/16 - 20	9/16 - 18
2406-05-04	1/2 - 20	7/16 - 20
2406-06-04	9/16 - 18	7/16 - 20
2406-06-05	9/16 - 18	1/2 - 20
2406-06-08	9/16 - 18	3/4 - 16
2406-08-04	3/4 - 16	7/16 - 20
2406-08-05	3/4 - 16	1/2 - 20
2406-08-06	3/4 - 16	9/16 - 18
2406-08-10	3/4 - 16	7/8 - 14
2406-08-12	3/4 - 16	1-1/16 - 12
2406-10-04	7/8 - 14	7/16 - 20
2406-10-06	7/8 - 14	9/16 - 18
2406-10-08	7/8 - 14	3/4 - 16
2406-10-12	7/8 - 14	1-1/16 - 12
2406-12-04	1-1/16 - 12	7/16 - 20
2406-12-06	1-1/16 - 12	9/16 - 18
2406-12-08	1-1/16 - 12	3/4 - 16
2406-12-10	1-1/16 - 12	7/8 - 14
2406-12-16	1-1/16 - 12	1-5/16 - 12
2406-14-06	1-3/16 - 12	9/16 - 18
2406-14-08	1-3/16 - 12	3/4 - 16
2406-14-10	1-3/16 - 12	7/8 - 14
2406-14-12	1-3/16 - 12	1-1/16 - 12
2406-16-04	1-5/16 - 12	7/16 - 20
2406-16-06	1-5/16 - 12	9/16 - 18
2406-16-08	1-5/16 - 12	3/4 - 16
2406-16-10	1-5/16 - 12	7/8 - 14
2406-16-12	1-5/16 - 12	1-1/16 - 12
2406-16-14	1-5/16 - 12	1-3/16 - 12
2406-16-20	1-5/16 - 12	1-5/8 - 12
2406-20-08	1-5/8 - 12	3/4 - 16
2406-20-10	1-5/8 - 12	7/8 - 14
2406-20-12	1-5/8 - 12	1-1/16 - 12
2406-20-16	1-5/8 - 12	1-5/16 - 12
2406-20-24	1-5/8 - 12	1-7/8 - 12
2406-24-08	1-7/8 - 12	3/4 - 16
2406-24-12	1-7/8 - 12	1-1/16 - 12
2406-24-16	1-7/8 - 12	1-5/16 - 12
2406-24-20	1-7/8 - 12	1-5/8 - 12
2406-32-24	2-1/2 - 12	1-7/8 - 12

JIC 37° FLARE ADAPTERS

2408 ...JIC HEX PLUG

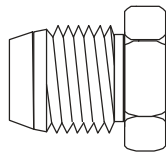

	MALE JIC
2408-02	5/16 - 24
2408-03	3/8 - 24
2408-04	7/16 - 20
2408-05	1/2 - 20
2408-06	9/16 - 18
2408-08	3/4 - 16
2408-10	7/8 - 14
2408-12	1-1/16 - 12
2408-14	1-3/16 - 12
2408-16	1-5/16 - 12
2408-20	1-5/8 - 12
2408-24	1-7/8 - 12
2408-32	2-1/2 - 12

2501 ...JIC - PIPE 90° ELBOW

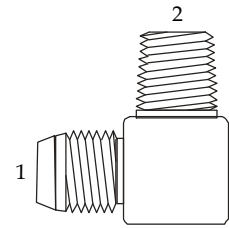

(1) (2)	MALE JIC	MALE PIPE
2501-02-02	5/16 - 24	1/8" - 27
2501-03-02	3/8 - 24	1/8" - 27
2501-04-02	7/16 - 20	1/8" - 27
2501-04-04	7/16 - 20	1/4" - 18
2501-04-06	7/16 - 20	3/8" - 18
2501-04-08	7/16 - 20	1/2" - 14
2501-04-12	7/16 - 20	3/4" - 14
2501-05-02	1/2 - 20	1/8" - 27
2501-05-04	1/2 - 20	1/4" - 18
2501-05-06	1/2 - 20	3/8" - 18
2501-05-08	1/2 - 20	1/2" - 14
2501-06-02	9/16 - 18	1/8" - 27
2501-06-04	9/16 - 18	1/4" - 18
2501-06-06	9/16 - 18	3/8" - 18
2501-06-08	9/16 - 18	1/2" - 14
2501-06-12	9/16 - 18	3/4" - 14

2500 ...JIC UNION 90° ELBOW

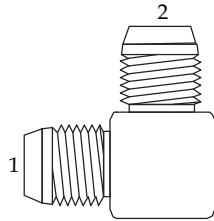

(1) (2)	MALE JIC	MALE JIC	
2500-02-02	5/16 - 24	5/16 - 24	
2500-03-03	3/8 - 24	3/8 - 24	
2500-04-04	7/16 - 20	7/16 - 20	
2500-05-04	1/2 - 20	7/16 - 20	
2500-05-05	1/2 - 20	1/2 - 20	
2500-06-04	9/16 - 18	7/16 - 20	
2500-06-05	9/16 - 18	1/2 - 20	
2500-06-06	9/16 - 18	9/16 - 18	
2500-08-04	3/4 - 16	7/16 - 20	
2500-08-06	3/4 - 16	9/16 - 20	
2500-08-08	3/4 - 16	3/4 - 16	
2500-10-08	7/8 - 14	3/4 - 16	
2500-10-10	7/8 - 14	7/8 - 14	
2500-12-06	1-1/16 - 12	9/16 - 20	
2500-12-08	1-1/16 - 12	3/4 - 16	
2500-12-10	1-1/16 - 12	7/8 - 14	
2500-12-12	1-1/16 - 12	1-1/16 - 12	
2500-14-14	1-3/16 - 12	1-3/16 - 12	
2500-16-12	1-5/16 - 12	1-1/16 - 12	
2500-16-16	1-5/16 - 12	1-5/16 - 12	
2500-20-20	1-5/8 - 12	1-5/8 - 12	
2500-24-24	1-7/8 - 12	1-7/8 - 12	
2500-32-32	2-1/2 - 12	2-1/2 - 12	
2501-08-02	3/4 - 16		1/8" - 27
2501-08-04	3/4 - 16		1/4" - 18
2501-08-06	3/4 - 16		3/8" - 18
2501-08-08	3/4 - 16		1/2" - 14
2501-08-12	3/4 - 16		3/4" - 14
2501-08-16	3/4 - 16		1" - 11-1/2
2501-10-06	7/8 - 14		3/8" - 18
2501-10-08	7/8 - 14		1/2" - 14
2501-10-12	7/8 - 14		3/4" - 14
2501-10-16	7/8 - 14		1" - 11-1/2
2501-12-06	1-1/16 - 12		3/8" - 18
2501-12-08	1-1/16 - 12		1/2" - 14
2501-12-12	1-1/16 - 12		3/4" - 14
2501-12-16	1-1/16 - 12		1" - 11-1/2
2501-14-12	1-3/16 - 12		3/4" - 14
2501-16-06	1-5/16 - 12		3/8" - 18
2501-16-08	1-5/16 - 12		1/2" - 14
2501-16-12	1-5/16 - 12		3/4" - 14
2501-16-16	1-5/16 - 12		1" - 11-1/2
2501-16-20	1-5/16 - 12		1-1/4" - 11-1/2
2501-16-24	1-5/16 - 12		1-1/2" - 11-1/2
2501-20-16	1-5/8 - 12		1" - 11-1/2
2501-20-20	1-5/8 - 12		1-1/4" - 11-1/2
2501-20-24	1-5/8 - 12		1-1/2" - 11-1/2
2501-24-16	1-7/8 - 12		1" - 11-1/2
2501-24-20	1-7/8 - 12		1-1/4" - 11-1/2
2501-24-24	1-7/8 - 12		1-1/2" - 11-1/2
2501-24-32	1-7/8 - 12		2" - 11-1/2
2501-32-24	2-1/2 - 12		1-1/2" - 11-1/2
2501-32-32	2-1/2 - 12		2" - 11-1/2

JIC 37° FLARE ADAPTERS

2501L ...JIC - PIPE 90° ELBOW LONG

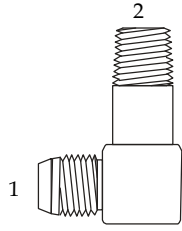

(1) (2)	MALE JIC	MALE PIPE
2501-L-04-02	7/16 - 20	1/8" - 27
2501-L-04-04	7/16 - 20	1/4" - 18
2501-L-05-02	1/2 - 20	1/8" - 27
2501-L-05-04	1/2 - 20	1/4" - 18
2501-L-06-02	9/16 - 18	1/8" - 27
2501-L-06-04	9/16 - 18	1/4" - 18
2501-L-06-06	9/16 - 18	3/8" - 18
2501-L-06-08	9/16 - 18	1/2" - 14
2501-L-08-04	3/4 - 16	1/4" - 18
2501-L-08-06	3/4 - 16	3/8" - 18
2501-L-08-08	3/4 - 16	1/2" - 14
2501-L-08-12	3/4 - 16	3/4" - 14
2501-L-10-08	7/8 - 14	1/2" - 14
2501-L-10-12	7/8 - 14	3/4" - 14
2501-L-12-08	1-1/16 - 12	1/2" - 14
2501-L-12-12	1-1/16 - 12	3/4" - 14
2501-L-12-16	1-1/16 - 12	1" - 11-1/2
2501-L-14-12	1-3/16 - 12	3/4" - 14
2501-L-16-12	1-5/16 - 12	3/4" - 14
2501-L-16-16	1-5/16 - 12	1" - 11-1/2
2501-L-20-20	1-5/8 - 12	1-1/4" - 11-1/2
2501-L-24-24	1-7/8 - 12	1-1/2" - 11-1/2

2501LL ...JIC - PIPE 90° ELBOW X LONG

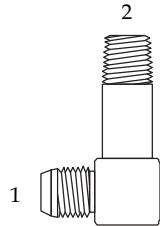

(1) (2)	MALE JIC	MALE PIPE
2501-LL-04-02	7/16 - 20	1/8" - 27
2501-LL-04-04	7/16 - 20	1/4" - 18
2501-LL-05-02	1/2 - 20	1/8" - 27
2501-LL-05-04	1/2 - 20	1/4" - 18
2501-LL-06-04	9/16 - 18	1/4" - 18
2501-LL-06-06	9/16 - 18	3/8" - 18
2501-LL-06-08	9/16 - 18	1/2" - 14
2501-LL-08-06	3/4 - 16	3/8" - 18
2501-LL-08-08	3/4 - 16	1/2" - 14
2501-LL-10-08	7/8 - 14	1/2" - 14
2501-LL-12-08	1-1/16 - 12	1/2" - 14
2501-LL-12-12	1-1/16 - 12	3/4" - 14
2501-LL-16-12	1-5/16 - 12	3/4" - 14
2501-LL-16-16	1-5/16 - 12	1" - 11-1/2
2501-LL-20-20	1-5/8 - 12	1-1/4" - 11-1/2
2501-LL-24-24	1-7/8 - 12	1-1/2" - 11-1/2
2501-LL-32-32	2-1/2 - 12	2" - 11-1/2

2501LLL ...JIC - PIPE 90° ELBOW XX LONG

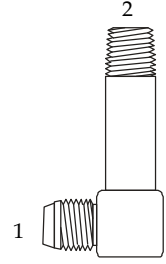

(1) (2)	MALE JIC	MALE PIPE
2501-LLL-04-02	7/16 - 20	1/8" - 27
2501-LLL-04-04	7/16 - 20	1/4" - 18
2501-LLL-05-02	1/2 - 20	1/8" - 27
2501-LLL-06-04	9/16 - 18	1/4" - 18
2501-LLL-06-06	9/16 - 18	3/8" - 18
2501-LLL-08-06	3/4 - 16	3/8" - 18
2501-LLL-08-08	3/4 - 16	1/2" - 14
2501-LLL-10-08	7/8 - 14	1/2" - 14
2501-LLL-12-12	1-1/16 - 12	3/4" - 14
2501-LLL-16-16	1-5/16 - 12	1" - 11-1/2
2501-LLL-20-20	1-5/8 - 12	1-1/4" - 11-1/2

2502 ...JIC - PIPE 90° ELBOW

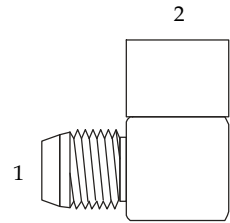

(1) (2)	MALE JIC	FEMALE PIPE
2502-02-02	5/16 - 24	1/8" - 27
2502-03-02	3/8 - 24	1/8" - 27
2502-04-02	7/16 - 20	1/8" - 27
2502-04-04	7/16 - 20	1/4" - 18
2502-04-06	7/16 - 20	3/8" - 18
2502-05-02	1/2 - 20	1/8" - 27
2502-05-04	1/2 - 20	1/4" - 18
2502-06-02	9/16 - 18	1/8" - 27
2502-06-04	9/16 - 18	1/4" - 18
2502-06-06	9/16 - 18	3/8" - 18
2502-06-08	9/16 - 18	1/2" - 14
2502-08-04	3/4 - 16	1/4" - 18
2502-08-06	3/4 - 16	3/8" - 18
2502-08-08	3/4 - 16	1/2" - 14
2502-08-12	3/4 - 16	3/4" - 14
2502-10-08	7/8 - 14	1/2" - 14
2502-12-08	1-1/16 - 12	1/2" - 14
2502-12-12	1-1/16 - 12	3/4" - 14
2502-12-16	1-1/16 - 12	1" - 11-1/2
2502-14-12	1-3/16 - 12	3/4" - 14
2502-16-12	1-5/16 - 12	3/4" - 14
2502-16-16	1-5/16 - 12	1" - 11-1/2
2502-20-20	1-5/8 - 12	1-1/4" - 11-1/2
2502-24-24	1-7/8 - 12	1-1/2" - 11-1/2
2502-32-32	2-1/2 - 12	2" - 11-1/2

JIC 37° FLARE ADAPTERS

2503 ...JIC - PIPE 45° ELBOW

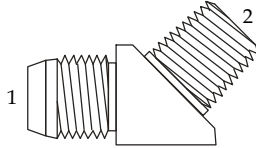

(1) (2)	MALE JIC	MALE PIPE
2503-02-02	5/16 -24	1/8" -27
2503-03-02	3/8 -24	1/8" -27
2503-04-02	7/16 -20	1/8" -27
2503-04-04	7/16 -20	1/4" -18
2503-04-06	7/16 -20	3/8" -18
2503-04-08	7/16 -20	1/2" -14
2503-05-02	1/2 -20	1/8" -27
2503-05-04	1/2 -20	1/4" -18
2503-06-02	9/16 -18	1/8" -27
2503-06-04	9/16 -18	1/4" -18
2503-06-06	9/16 -18	3/8" -18
2503-06-08	9/16 -18	1/2" -14
2503-06-12	9/16 -18	3/4" -14
2503-08-04	3/4 -16	1/4" -18
2503-08-06	3/4 -16	3/8" -18
2503-08-08	3/4 -16	1/2" -14
2503-08-12	3/4 -16	3/4" -14
2503-10-06	7/8 -14	3/8" -18
2503-10-08	7/8 -14	1/2" -14
2503-10-12	7/8 -14	3/4" -14
2503-12-08	1-1/16 -12	1/2" -14
2503-12-12	1-1/16 -12	3/4" -14
2503-12-16	1-1/16 -12	1" -11-1/2
2503-14-12	1-3/16 -12	3/4" -14
2503-16-08	1-5/16 -12	1/2" -14
2503-16-12	1-5/16 -12	3/4" -14
2503-16-16	1-5/16 -12	1" -11-1/2
2503-16-20	1-5/16 -12	1-1/4" -11-1/2
2503-20-16	1-5/8 -12	1" -11-1/2
2503-20-20	1-5/8 -12	1-1/4" -11-1/2
2503-20-24	1-5/8 -12	1-1/2" -11-1/2
2503-24-24	1-7/8 -12	1-1/2" -11-1/2
2503-32-32	2-1/2 -12	2" -11-1/2

2504 ...JIC 45° ELBOW

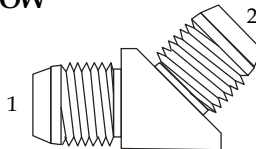

	(1) MALE JIC	(2) MALE JIC
2504-03-03	3/8 -24	3/8 -24
2504-04-04	7/16 -20	7/16 -20
2504-06-04	9/16 -18	7/16 -20
2504-06-06	9/16 -18	9/16 -18
2504-08-08	3/4 -16	3/4 -16
2504-10-10	7/8 -14	7/8 -14
2504-12-12	1-1/16 -12	1-1/16 -12
2504-16-16	1-5/16 -12	1-5/16 -12

2505 ...JIC - PIPE 45° ELBOW

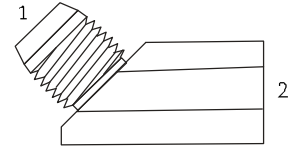

(1) (2)	(1) MALE JIC	(2) FEMALE PIPE
2505-04-02	7/16 -20	1/8 -27
2505-04-04	7/16 -20	1/4 -18
2505-06-04	9/16 -18	1/4 -18
2505-06-06	9/16 -18	3/8 -18
2505-08-06	3/4 -16	3/8 -18
2505-08-08	3/4 -16	1/2 -14
2505-10-08	7/8 -14	1/2 -14
2505-12-12	1-1/16 -12	3/4 -14
2505-16-16	1-5/16 -12	1" -11-1/2

2601 ...JIC - PIPE BRANCH TEE

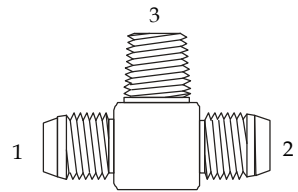

(1) (2) (3)	(1) (2) MALE JIC	MALE PIPE
2601-03-03-02	3/8 -24	1/8" -27
2601-04-04-02	7/16 -20	1/8" -27
2601-04-04-04	7/16 -20	1/4" -18
2601-04-04-06	7/16 -20	3/8" -18
2601-05-05-02	1/2 -20	1/8" -27
2601-05-05-04	1/2 -20	1/4" -18
2601-06-06-04	9/16 -18	1/4" -18
2601-06-06-06	9/16 -18	3/8" -18
2601-06-06-08	9/16 -18	1/2" -14
2601-08-08-06	3/4 -16	3/8" -18
2601-08-08-08	3/4 -16	1/2" -14
2601-10-10-06	7/8 -14	3/8" -18
2601-10-10-08	7/8 -14	1/2" -14
2601-12-12-08	1-1/16 -12	1/2" -14
2601-12-12-12	1-1/16 -12	3/4" -14
2601-14-14-12	1-3/16 -12	3/4" -14
2601-16-16-12	1-5/16 -12	3/4" -14
2601-16-16-16	1-5/16 -12	1" -11-1/2
2601-20-20-20	1-5/8 -12	1-1/4" -11-1/2
2601-24-24-24	1-7/8 -12	1-1/2" -11-1/2
2601-32-32-32	2-1/2 -12	2" -11-1/2

JIC 37° FLARE ADAPTERS

2602 ...JIC - PIPE BRANCH TEE

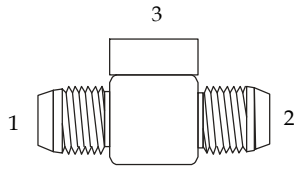

(1) (2) (3)	MALE JIC	FEMALE PIPE
2602-04-04-02	7/16 - 20	1/8" - 27
2602-04-04-04	7/16 - 20	1/4" - 18
2602-05-05-02	1/2 - 20	1/8" - 27
2602-05-05-04	1/2 - 20	1/4" - 18
2602-06-06-04	9/16 - 18	1/4" - 18
2602-06-06-06	9/16 - 18	3/8" - 18
2602-08-08-06	3/4 - 16	3/8" - 18
2602-08-08-04	3/4 - 16	1/4" - 18
2602-08-08-08	3/4 - 16	1/2" - 14
2602-10-10-08	7/8 - 14	1/2" - 14
2602-12-12-12	1-1/16 - 12	3/4" - 14
2602-16-16-16	1-5/16 - 12	1" - 11-1/2
2602-20-20-20	1-5/8 - 12	1-1/4" - 11-1/2
2602-24-24-24	1-7/8 - 12	1-1/2" - 11-1/2
2602-32-32-32	2-1/2 - 12	2" - 11-1/2

2605 ...JIC - PIPE RUN TEE

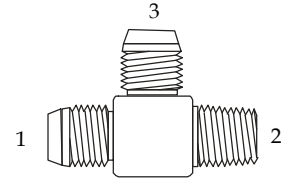

(1) (2) (3)	MALE JIC	MALE PIPE	MALE JIC
2605-03-02-03	3/8 - 24	1/8" - 27	3/8 - 24
2605-04-02-04	7/16 - 20	1/8" - 27	7/16 - 20
2605-04-04-04	7/16 - 20	1/4" - 18	7/16 - 20
2605-05-02-05	1/2 - 20	1/8" - 27	1/2 - 20
2605-05-04-05	1/2 - 20	1/4" - 18	1/2 - 20
2605-06-02-06	9/16 - 18	1/8" - 27	9/16 - 18
2605-06-04-04	9/16 - 18	1/4" - 18	7/16 - 20
2605-06-04-06	9/16 - 18	1/4" - 18	9/16 - 18
2605-06-06-06	9/16 - 18	3/8" - 18	9/16 - 18
2605-06-08-06	9/16 - 18	1/2" - 14	9/16 - 18
2605-08-04-08	3/4 - 16	1/4" - 18	3/4 - 16
2605-08-06-08	3/4 - 16	3/8" - 18	3/4 - 16
2605-08-08-06	3/4 - 16	1/2" - 14	9/16 - 18
2605-08-08-08	3/4 - 16	1/2" - 14	3/4 - 16
2605-10-08-10	7/8 - 14	1/2" - 14	7/8 - 14
2605-12-08-12	1-1/16 - 12	1/2" - 14	1-1/16 - 12
2605-12-12-08	1-1/16 - 12	3/4" - 14	7/8 - 14
2605-12-12-12	1-1/16 - 12	3/4" - 14	1-1/16 - 12
2605-14-12-14	1-3/16 - 12	3/4" - 14	1-3/16 - 12
2605-16-12-16	1-5/16 - 12	3/4" - 14	1-5/16 - 12
2605-16-16-16	1-5/16 - 12	1" - 11-1/2	1-5/16 - 12
2605-20-16-20	1-5/8 - 12	1" - 11-1/2	1-5/8 - 12
2605-20-20-20	1-5/8 - 12	1-1/4" - 11-1/2	1-5/8 - 12
2605-24-24-24	1-7/8 - 12	1-1/2" - 11-1/2	1-7/8 - 12
2605-32-32-32	2-1/2 - 12	2" - 11-1/2	2-1/2 - 12

2603 ...JIC UNION TEE

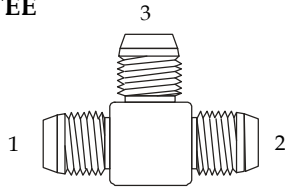

(1) (2) (3)	(1)(2) MALE JIC	(3) MALE JIC
2603-02-02-02	5/16 - 24	5/16 - 24
2603-03-03-03	3/8 - 24	3/8 - 24
2603-04-04-04	7/16 - 20	7/16 - 20
2603-04-04-06	7/16 - 20	9/16 - 18
2603-05-05-05	1/2 - 20	1/2 - 20
2603-06-06-04	9/16 - 18	7/16 - 20
2603-06-06-06	9/16 - 18	9/16 - 18
2603-06-06-08	9/16 - 18	3/4 - 16
2603-08-08-06	3/4 - 16	9/16 - 18
2603-08-08-08	3/4 - 16	3/4 - 16
2603-08-08-10	3/4 - 16	7/8 - 14
2603-08-08-12	3/4 - 16	1-1/16 - 12
2603-10-10-08	7/8 - 14	3/4 - 16
2603-10-10-10	7/8 - 14	7/8 - 14
2603-12-12-08	1-1/16 - 12	3/4 - 16
2603-12-12-10	1-1/16 - 12	7/8 - 14
2603-12-12-12	1-1/16 - 12	1-1/16 - 12
2603-14-14-14	1-3/16 - 12	1-3/16 - 12
2603-16-16-12	1-5/16 - 12	1-1/16 - 12
2603-16-16-16	1-5/16 - 12	1-5/16 - 12
2603-16-16-20	1-5/16 - 12	1-5/8 - 12
2603-20-16-16	1-5/8 - 12	1-5/16 - 12
2603-20-20-16	1-5/8 - 12	1-5/16 - 12
2603-20-20-20	1-5/8 - 12	1-5/8 - 12
2603-24-24-24	1-7/8 - 12	1-7/8 - 12
2603-32-32-32	2-1/2 - 12	2-1/2 - 12

2606 ...JIC - PIPE RUN TEE

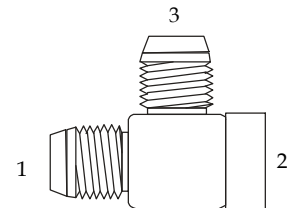

(1) (2) (3)	(1) MALE JIC	(2) FEMALE PIPE	(3) MALE JIC
2606-03-02-03	3/8 - 24	1/8" - 27	3/8 - 24
2606-04-02-04	7/16 - 20	1/8" - 27	7/16 - 20
2606-04-04-04	7/16 - 20	1/4" - 18	7/16 - 20
2606-06-04-06	9/16 - 18	1/4" - 18	9/16 - 18
2606-06-06-04	9/16 - 18	3/8" - 18	7/16 - 20
2606-06-06-06	9/16 - 18	3/8" - 18	9/16 - 18
2606-08-06-08	3/4 - 16	3/8" - 18	3/4 - 16
2606-08-08-08	3/4 - 16	1/2" - 14	3/4 - 16
2606-10-08-10	7/8 - 14	1/2" - 14	7/8 - 14
2606-12-12-12	1-1/16 - 12	3/4" - 14	1-1/16 - 12
2606-14-12-14	1-3/16 - 12	3/4" - 14	1-3/16 - 12
2606-16-16-16	1-5/16 - 12	1" - 11-1/2	1-5/16 - 12
2606-20-20-20	1-5/8 - 12	1-1/4" - 11-1/2	1-5/8 - 12
2606-24-24-24	1-7/8 - 12	1-1/2" - 11-1/2	1-7/8 - 12
2606-32-32-32	2-1/2 - 12	2" - 11-1/2	2-1/2 - 12

JIC 37° FLARE ADAPTERS

2650 ...JIC MALE CROSS

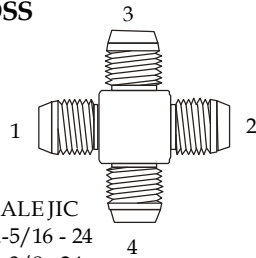

(1) (2) (3) (4)	MALE JIC
2650-02-02-02-02	02-5/16 - 24
2650-04-04-04-04	03-3/8 - 24
2650-05-05-05-05	04-7/16 - 20
2650-06-06-06-06	05-1/2 - 20
2650-06-08-06-08	06-9/16 - 18
2650-08-08-08-08	08-3/4 - 16
2650-10-10-10-10	10-7/8 - 14
2650-12-12-12-12	12-1-1/16 - 12
2650-14-14-14-14	14-1-3/16 - 12
2650-16-16-16-16	16-1-5/16 - 12
2650-20-20-20-20	20-1-5/8 - 12
2650-24-24-24-24	24-1-7/8 - 12
2650-32-32-32-32	32-2-1/2 - 12

2702 ...JIC BULKHEAD 45° ELBOW

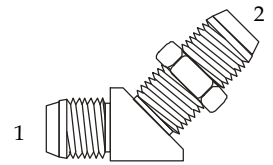

(1) (2)	MALE JIC	MALE JIC
2702-03-03	3/8 - 24	3/8 - 24
2702-04-04	7/16 - 20	7/16 - 20
2702-05-05	1/2 - 20	1/2 - 20
2702-06-06	9/16 - 18	9/16 - 18
2702-08-06	3/4 - 16	9/16 - 18
2702-08-08	3/4 - 16	3/4 - 16
2702-10-10	7/8 - 14	7/8 - 14
2702-12-12	1-1/16 - 12	1-1/16 - 12
2702-14-14	1-3/16 - 12	1-3/16 - 12
2702-16-16	1-5/16 - 12	1-5/16 - 12
2702-20-20	1-5/8 - 12	1-5/8 - 12
2702-24-24	1-7/8 - 12	1-7/8 - 12
2702-32-32	2-1/2 - 12	2-1/2 - 12

2700 ...JIC MALE BULKHEAD

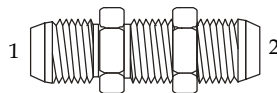

(1) (2)	MALE JIC	MALE JIC
2700-02-02	5/16 - 24	5/16 - 24
2700-03-03	3/8 - 24	3/8 - 24
2700-04-04	7/16 - 20	7/16 - 20
2700-05-05	1/2 - 20	1/2 - 20
2700-06-04	9/16 - 18	7/16 - 20
2700-06-06	9/16 - 18	9/16 - 18
2700-08-08	3/4 - 16	3/4 - 16
2700-10-10	7/8 - 14	7/8 - 14
2700-12-12	1-1/16 - 12	1-1/16 - 12
2700-14-14	1-3/16 - 12	1-3/16 - 12
2700-16-16	1-5/16 - 12	1-5/16 - 12
2700-20-20	1-5/8 - 12	1-5/8 - 12
2700-24-24	1-7/8 - 12	1-7/8 - 12
2700-32-32	2-1/2 - 12	2-1/2 - 12

2703 ...JIC BULKHEAD TEE

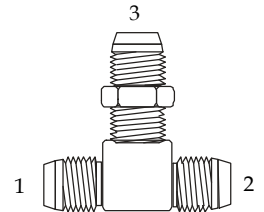

(1) (2) (3)	MALE JIC
2703-03-03-03	3/8 - 24
2703-04-04-04	7/16 - 20
2703-05-05-05	1/2 - 20
2703-06-06-06	9/16 - 18
2703-08-08-08	3/4 - 16
2703-10-10-10	7/8 - 14
2703-12-12-12	1-1/16 - 12
2703-16-16-16	1-5/16 - 12
2703-20-20-20	1-5/8 - 12
2703-24-24-24	1-7/8 - 12

2701 ...JIC BULKHEAD 90° ELBOW

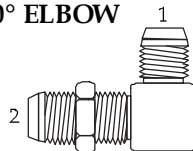

(1) (2)	MALE JIC	MALE JIC
2701-02-02	5/16 - 24	5/16 - 24
2701-03-03	3/8 - 24	3/8 - 24
2701-04-04	7/16 - 20	7/16 - 20
2701-05-05	1/2 - 20	1/2 - 20
2701-06-06	9/16 - 18	9/16 - 18
2701-08-08	3/4 - 16	3/4 - 16
2701-10-10	7/8 - 14	7/8 - 14
2701-12-12	1-1/16 - 12	1-1/16 - 12
2701-14-14	1-3/16 - 12	1-3/16 - 12
2701-16-16	1-5/16 - 12	1-5/16 - 12
2701-20-20	1-5/8 - 12	1-5/8 - 12
2701-24-24	1-7/8 - 12	1-7/8 - 12

JIC 37° FLARE ADAPTERS

2704 ...JIC BULKHEAD TEE

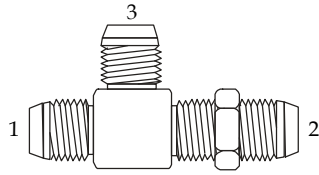

(1) (2) (3)	MALE JIC
2704-03-03-03	3/8 - 24
2704-04-04-04	7/16 - 20
2704-05-05-05	1/2 - 20
2704-06-06-06	9/16 - 18
2704-08-08-08	3/4 - 16
2704-10-10-10	7/8 - 14
2704-12-12-12	1-1/16 - 12
2704-16-16-16	1-5/16 - 12
2704-20-20-20	1-5/8 - 12

2705 ...JIC BULKHEAD - FEMALE PIPE

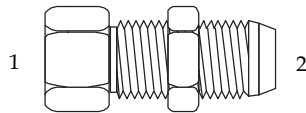

(1) (2)	FEMALE PIPE	MALE JIC
2705-02-04	1/8" - 27	7/16 - 20
2705-04-02	1/4" - 18	5/16 - 24
2705-04-04	1/4" - 18	7/16 - 20
2705-04-06	1/4" - 18	9/16 - 18
2705-06-04	3/8" - 18	7/16 - 20
2705-06-06	3/8" - 18	9/16 - 18
2705-06-08	3/8" - 18	3/4 - 16
2705-08-08	1/2" - 14	3/4 - 16
2705-08-10	1/2" - 14	7/8 - 14
2705-12-12	3/4" - 14	1-1/16 - 12
2705-12-14	3/4" - 14	1-3/16 - 12
2705-16-16	1" - 11-1/2	1-5/16 - 12
2705-20-20	1-1/4" - 11-1/2	1-5/8 - 12
2705-24-24	1-1/2" - 11-1/2	1-7/8 - 12

2706 ...JIC BULKHEAD - MALE PIPE

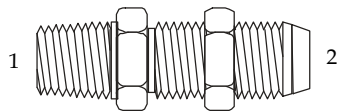

(1) (2)	MALE PIPE	MALE JIC
2706-02-04	1/8" - 27	7/16 - 20
2706-04-04	1/4" - 18	7/16 - 20
2706-04-06	1/4" - 18	9/16 - 18
2706-06-06	3/8" - 18	9/16 - 18
2706-06-08	3/8" - 18	3/4 - 16
2706-08-08	1/2" - 14	3/4 - 16
2706-08-10	1/2" - 14	3/4 - 16
2706-08-12	1/2" - 14	3/4 - 16
2706-12-12	3/4" - 14	1-1/16 - 12
2706-16-16	1" - 11-1/2	1-5/16 - 12
2706-20-20	1-1/4" - 11-1/2	1-5/8 - 12
2706-24-24	1-1/2" - 11-1/2	1-7/8 - 12
2706-32-32	2" - 11-1/2	2-1/2 - 12

6500 ...JIC SWIVEL 90° ELBOW

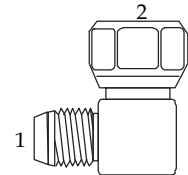

(1) (2)	MALE JIC	FEMALE JIC
6500-03-03	3/8 - 24	3/8 - 24
6500-04-04	7/16 - 20	7/16 - 20
6500-04-06	7/16 - 20	9/16 - 18
6500-05-05	1/2 - 20	1/2 - 20
6500-06-04	9/16 - 18	7/16 - 20
6500-06-06	9/16 - 18	9/16 - 18
6500-06-08	9/16 - 18	3/4 - 16
6500-08-06	3/4 - 16	9/16 - 18
6500-08-08	3/4 - 16	3/4 - 16
6500-08-10	3/4 - 16	7/8 - 14
6500-08-12	3/4 - 16	1-1/16 - 12
6500-10-08	7/8 - 14	3/4 - 16
6500-10-10	7/8 - 14	7/8 - 14
6500-10-12	7/8 - 14	1-1/16 - 12

6500-12-10	1-1/16 - 12	7/8 - 14
6500-12-12	1-1/16 - 12	1-1/16 - 12
6500-12-16	1-1/16 - 12	1-5/16 - 12
6500-14-14	1-3/16 - 12	1-3/16 - 12
6500-16-16	1-5/16 - 12	1-5/16 - 12
6500-20-20	1-5/8 - 12	1-5/8 - 12
6500-24-24	1-7/8 - 12	1-7/8 - 12
6500-32-32	2-1/2 - 12	2-1/2 - 12

6501 ...PIPE - JIC SWIVEL 90° ELBOW

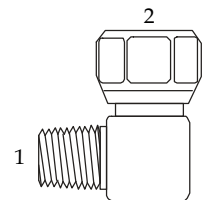

(1) (2)	MALE PIPE	FEMALE JIC
6501-02-04	1/8" - 27	7/16 - 20
6501-04-04	1/4" - 18	7/16 - 20
6501-04-06	1/4" - 18	9/16 - 18
6501-06-04	3/8" - 18	7/16 - 20
6501-06-06	3/8" - 18	9/16 - 18
6501-06-08	3/8" - 18	3/4 - 16
6501-08-06	1/2" - 14	9/16 - 18
6501-08-08	1/2" - 14	3/4 - 16
6501-08-10	1/2" - 14	7/8 - 14
6501-12-08	3/4" - 14	3/4 - 16
6501-12-12	3/4" - 14	1-1/16 - 12
6501-16-16	1" - 11-1/2	1-5/16 - 12
6501-20-20	1-1/4" - 11-1/2	1-5/8 - 12
6501-24-24	1-1/2" - 11-1/2	1-7/8 - 12
6501-32-32	2" - 11-1/2	2-1/2 - 12

JIC 37° FLARE ADAPTERS

6502 ...JIC SWIVEL 45° ELBOW

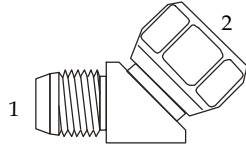

(1) (2)	MALE JIC	FEMALE JIC
6502-02-02	5/16 - 24	5/16 - 24
6502-04-04	7/16 - 20	7/16 - 20
6502-05-05	1/2 - 20	1/2 - 20
6502-06-06	9/16 - 18	9/16 - 18
6502-08-08	3/4 - 16	3/4 - 16
6502-10-08	7/8 - 14	3/4 - 16
6502-10-10	7/8 - 14	7/8 - 14
6502-12-12	1-1/16 - 12	1-1/16 - 12
6502-14-14	1-3/16 - 12	1-3/16 - 12
6502-16-16	1-5/16 - 12	1-5/16 - 12
6502-20-20	1-5/8 - 12	1-5/8 - 12
6502-24-24	1-7/8 - 12	1-7/8 - 12
6502-32-32	2-1/2 - 12	2-1/2 - 12

6503 ...FEMALE PIPE - JIC SWIVEL 90° ELBOW

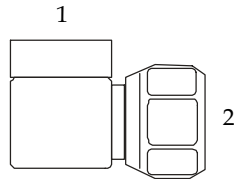

(1) (2)	FEMALE PIPE	FEMALE JIC
6503-04-04	1/4" - 18	7/16 - 20
6503-06-06	3/8" - 18	9/16 - 18
6503-08-08	1/2" - 14	3/4 - 16
6503-12-12	3/4" - 14	1-1/16 - 12
6503-16-16	1" - 11-1/2	1-5/16 - 12

6504 ...JIC SWIVEL CONNECTOR

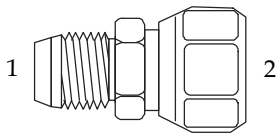

(1) (2)	MALE JIC	FEMALE JIC
6504-04-04	7/16-20	7/16-20
6504-04-06	7/16-20	9/16-18
6504-05-05	1/2-20	1/2-20
6504-06-04	9/16-18	7/16-20
6504-06-06	9/16-18	9/16-18
6504-06-08	9/16-18	3/4-16
6504-08-06	3/4-16	9/16-18
6504-08-08	3/4-16	3/4-16
6504-10-10	7/8-14	7/8-14
6504-12-12	1-1/16-12	1-1/16-12
6504-16-16	1-5/16-12	1-5/16-12
6504-20-20	1-5/8-12	1-5/8-12
6504-24-24	1-7/8-12	1-7/8-12

6505 ...JIC SWIVEL - PIPE

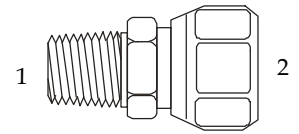

(1) (2)	MALE PIPE	FEMALE JIC
6505-02-04	1/8" - 27	7/16 - 20
6505-04-04	1/4" - 18	7/16 - 20
6505-04-05	1/4" - 18	1/2 - 20
6505-04-06	1/4" - 18	9/16 - 18
6505-06-04	3/8" - 18	7/16 - 20
6505-06-06	3/8" - 18	9/16 - 18
6505-06-08	3/8" - 18	3/4 - 16
6505-06-10	3/8" - 18	7/8 - 14
6505-08-06	1/2" - 14	9/16 - 18
6505-08-08	1/2" - 14	3/4 - 16
6505-08-10	1/2" - 14	7/8 - 14
6505-12-08	3/4" - 14	3/4 - 16
6505-12-10	3/4" - 14	7/8 - 14
6505-12-12	3/4" - 14	1-1/16 - 12
6505-12-16	3/4" - 14	1-5/16 - 12
6505-16-12	1" - 11-1/2	1-1/16 - 12
6505-16-16	1" - 11-1/2	1-5/16 - 12
6505-20-20	1-1/4" - 11-1/2	1-5/8 - 12
6505-24-24	1-1/2" - 11-1/2	1-7/8 - 12
6505-32-32	2" - 11-1/2	2-1/2 - 12

6506 ...FEMALE PIPE - JIC SWIVEL

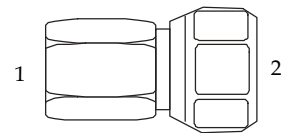

(1) (2)	FEMALE PIPE	FEMALE JIC
6506-04-02	1/4" - 18	5/16 - 24
6506-04-04	1/4" - 18	7/16 - 20
6506-04-06	1/4" - 18	9/16 - 18
6506-06-04	3/8" - 18	7/16 - 20
6506-06-06	3/8" - 18	9/16 - 18
6506-06-08	3/8" - 18	3/4 - 16
6506-06-10	3/8" - 18	7/8 - 14
6506-08-06	1/2" - 14	9/16 - 18
6506-08-08	1/2" - 14	3/4 - 16
6506-08-10	1/2" - 14	7/8 - 14
6506-12-10	3/4" - 14	7/8 - 14
6506-12-12	3/4" - 14	1-1/16 - 12
6506-16-16	1" - 11-1/2	1-5/16 - 12
6506-20-20	1-1/4" - 11-1/2	1-5/8 - 12
6506-24-24	1-1/2" - 11-1/2	1-7/8 - 12
6506-32-32	2" - 11-1/2	2-1/2 - 12

JIC 37° FLARE ADAPTERS

6565 ...JIC SWIVEL CONNECTOR

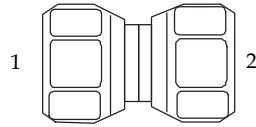

(1) (2)	FEMALE JIC	FEMALE JIC
6565-04-04	7/16 - 20	7/16 - 20
6565-06-06	9/16 - 18	9/16 - 18
6565-08-08	3/4 - 16	3/4 - 16
6565-10-10	7/8 - 14	7/8 - 14
6565-12-12	1-1/16 - 12	1-1/16 - 12
6565-16-16	1-5/16 - 12	1-5/16 - 12
6565-20-20	1-5/8 - 12	1-5/8 - 12

6602 ...JIC SWIVEL RUN TEE

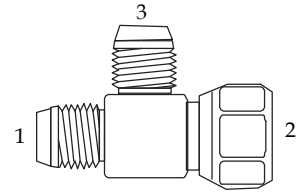

(1) (2) (3)	MALE JIC	FEMALE JIC	MALE JIC
6602-03-03-03	3/8 - 24	3/8 - 24	3/8 - 24
6602-04-04-04	7/16 - 20	7/16 - 20	7/16 - 20
6602-04-08-08	7/16 - 20	3/4 - 16	3/4 - 16
6602-05-05-05	1/2 - 20	1/2 - 20	1/2 - 20
6602-06-06-06	9/16 - 18	9/16 - 18	9/16 - 18
6602-08-06-08	3/4 - 16	9/16 - 18	3/4 - 16
6602-08-08-04	3/4 - 16	3/4 - 16	7/16 - 20
6602-08-08-08	3/4 - 16	3/4 - 16	3/4 - 16
6602-08-08-12	3/4 - 16	3/4 - 16	1-1/16 - 12

6600 ...JIC SWIVEL BRANCH TEE

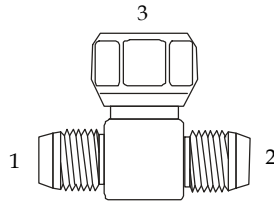

(1) (2) (3)	MALE JIC	FEMALE JIC
6600-03-03-03	3/8 - 24	3/8 - 24
6600-04-04-04	7/16 - 20	7/16 - 20
6600-05-05-05	1/2 - 20	1/2 - 20
6600-06-06-06	9/16 - 18	9/16 - 18
6600-06-06-08	9/16 - 18	3/4 - 16
6600-08-08-08	3/4 - 16	3/4 - 16
6600-10-10-10	7/8 - 14	7/8 - 14
6600-12-12-10	1-1/16 - 12	7/8 - 14
6600-12-12-12	1-1/16 - 12	1-1/16 - 12
6600-14-14-14	1-3/16 - 12	1-3/16 - 12
6600-16-16-16	1-5/16 - 12	1-5/16 - 12
6600-20-20-20	1-5/8 - 12	1-5/8 - 12
6600-24-24-24	1-7/8 - 12	1-7/8 - 12
6600-32-32-32	2-1/2 - 12	2-1/2 - 12

6603 ...JIC SWIVEL - JIC MALE BRANCH TEE

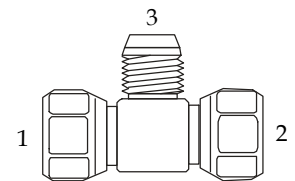

(1) (2) (3)	(1)(2) FEMALE JIC	(3) MALE JIC
6603-04-04-04	7/16 - 20	7/16 - 20
6603-06-06-06	9/16 - 18	9/16 - 18
6603-08-08-08	3/4 - 16	3/4 - 16
6603-10-10-10	7/8 - 14	7/8 - 14
6603-12-12-12	1-1/16 - 12	1-1/16 - 12
6603-16-16-16	1-5/16 - 12	1-5/16 - 12

JIC 37° FLARE ADAPTERS

6606 ...JIC SWIVEL TEE

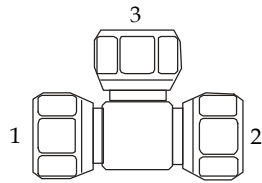

(1) (2) (3)	(1)(2)(3) FEMALE JIC
6606-04-04-04	7/16 - 20
6606-06-06-06	9/16 - 18
6606-08-08-08	3/4 - 16
6606-10-10-10	7/8 - 14
6606-12-12-12	1-1/16 - 12
6606-16-16-16	1-5/16 - 12

6801 ...JIC - ORB 90° ELBOW

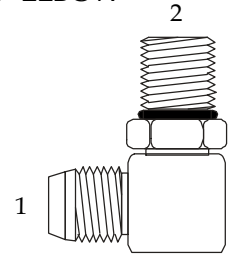

(1) (2)	MALE JIC	MALE ORB
6801-02-02	5/16 - 24	5/16 - 24
6801-02-04	5/16 - 24	7/16 - 20
6801-03-03	3/8 - 24	3/8 - 24
6801-03-04	3/8 - 24	7/16 - 20

6701 ...JIC SWIVEL BENT TUBE ELBOW 90°

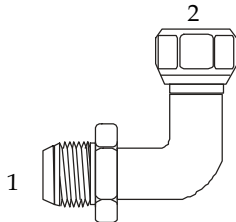

(1) (2)	MALE JIC	FEMALE JIC
6701-04-04	7/16 - 20	7/16 - 20
6701-06-06	9/16 - 18	9/16 - 18
6701-08-08	3/4 - 16	3/4 - 16
6701-10-10	7/8 - 14	7/8 - 14
6701-12-12	1-1/16 - 12	1-1/16 - 12
6701-16-16	1-5/16 - 12	1-5/16 - 12
6701-20-20	1-5/8 - 12	1-5/8 - 12

6801-04-02	7/16 - 20	5/16 - 24
6801-04-03	7/16 - 20	3/8 - 24
6801-04-04	7/16 - 20	7/16 - 20
6801-04-05	7/16 - 20	1/2 - 20
6801-04-06	7/16 - 20	9/16 - 18
6801-04-08	7/16 - 20	3/4 - 16

6801-05-04	1/2 - 20	7/16 - 20
6801-05-05	1/2 - 20	1/2 - 20
6801-05-06	1/2 - 20	9/16 - 18
6801-05-08	1/2 - 20	3/4 - 16
6801-05-10	1/2 - 20	7/8 - 14

6801-06-04	9/16 - 18	7/16 - 20
6801-06-05	9/16 - 18	1/2 - 20
6801-06-06	9/16 - 18	9/16 - 18
6801-06-08	9/16 - 18	3/4 - 16
6801-06-10	9/16 - 18	7/8 - 14
6801-06-12	9/16 - 18	1-1/16 - 12

6801-08-04	3/4 - 16	7/16 - 20
6801-08-05	3/4 - 16	1/2 - 20
6801-08-06	3/4 - 16	9/16 - 18
6801-08-08	3/4 - 16	3/4 - 16
6801-08-10	3/4 - 16	7/8 - 14
6801-08-12	3/4 - 16	1-1/16 - 12
6801-08-16	3/4 - 16	1-5/16 - 12

6701 ...JIC SWIVEL BENT TUBE ELBOW 90° LONG

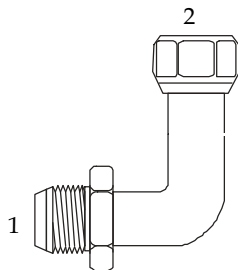

(1) (2)	MALE JIC	FEMALE JIC
6701L-04-04	7/16 - 20	7/16 - 20
6701L-06-06	9/16 - 18	9/16 - 18
6701L-08-08	3/4 - 16	3/4 - 16
6701L-10-10	7/8 - 14	7/8 - 14
6701L-12-12	1-1/16 - 12	1-1/16 - 12
6701L-16-16	1-5/16 - 12	1-5/16 - 12
6701L-20-20	1-5/8 - 12	1-5/8 - 12

6801-10-06	7/8 - 14	9/16 - 18
6801-10-08	7/8 - 14	3/4 - 16
6801-10-10	7/8 - 14	7/8 - 14
6801-10-12	7/8 - 14	1-1/16 - 12
6801-10-16	7/8 - 14	1-5/16 - 12
6801-10-20	7/8 - 14	1-5/8 - 16

6801-12-06	1-1/16 - 12	9/16 - 18
6801-12-08	1-1/16 - 12	3/4 - 16
6801-12-10	1-1/16 - 12	7/8 - 14
6801-12-12	1-1/16 - 12	1-1/16 - 12
6801-12-14	1-1/16 - 12	1-3/16 - 12
6801-12-16	1-1/16 - 12	1-5/16 - 12
6801-12-20	1-1/16 - 12	1-5/8 - 12

6801-14-12	1-3/16 - 12	1-1/16 - 12
6801-14-14	1-3/16 - 12	1-3/16 - 12
6801-14-16	1-3/16 - 12	1-5/16 - 12

...continued top of next page

JIC 37° FLARE ADAPTERS

...continued from previous page

(1) (2)	MALE JIC	MALE ORB
6801-16-08	1-5/16 - 12	3/4 - 16
6801-16-10	1-5/16 - 12	7/8 - 14
6801-16-12	1-5/16 - 12	1-1/16 - 12
6801-16-14	1-5/16 - 12	1-3/16 - 12
6801-16-16	1-5/16 - 12	1-5/16 - 12
6801-16-20	1-5/16 - 12	1-5/8 - 12
6801-16-24	1-5/16 - 12	1-7/8 - 12
6801-20-12	1-5/8 - 12	1-1/16 - 12
6801-20-14	1-5/8 - 12	1-3/16 - 12
6801-20-16	1-5/8 - 12	1-5/16 - 12
6801-20-20	1-5/8 - 12	1-5/8 - 12
6801-20-24	1-5/8 - 12	1-7/8 - 12
6801-24-16	1-7/8 - 12	1-5/16 - 12
6801-24-20	1-7/8 - 12	1-5/8 - 12
6801-24-24	1-7/8 - 12	1-7/8 - 12
6801-24-32	1-7/8 - 12	2-1/2 - 12
6801-32-24	2-1/2 - 12	1-7/8 - 12
6801-32-32	2-1/2 - 12	2-1/2 - 12

6801L ...JIC - ORB 90° LONG ELBOW

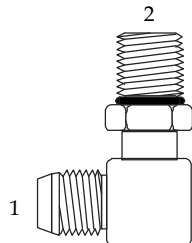

(1) (2)	MALE JIC	MALE ORB
6801-L-04-04	7/16 - 20	7/16 - 20
6801-L-06-06	9/16 - 18	9/16 - 18
6801-L-06-08	9/16 - 18	3/4 - 16
6801-L-08-06	3/4 - 16	9/16 - 18
6801-L-08-08	3/4 - 16	3/4 - 16
6801-L-08-10	3/4 - 16	7/8 - 14
6801-L-10-08	7/8 - 14	3/4 - 16
6801-L-10-10	7/8 - 14	7/8 - 14
6801-L-10-12	7/8 - 14	1-1/16 - 12
6801-L-12-10	1-1/16 - 12	7/8 - 14
6801-L-12-12	1-1/16 - 12	1-1/16 - 12
6801-L-16-12	1-5/16 - 12	1-1/16 - 12
6801-L-16-16	1-5/16 - 12	1-5/16 - 12
6801-L-20-20	1-5/8 - 12	1-5/8 - 12

6801LL ...JIC - ORB 90° X LONG ELBOW

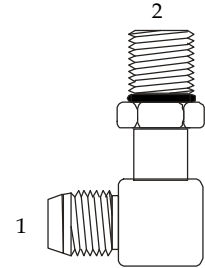

(1) (2)	MALE JIC	MALE ORB
6801-LL-04-04	7/16 - 20	7/16 - 20
6801-LL-04-06	7/16 - 20	9/16 - 18
6801-LL-06-06	9/16 - 18	9/16 - 18
6801-LL-06-08	9/16 - 18	3/4 - 16
6801-LL-08-06	3/4 - 16	9/16 - 18
6801-LL-08-08	3/4 - 16	3/4 - 16
6801-LL-08-10	3/4 - 16	7/8 - 14
6801-LL-10-08	7/8 - 14	3/4 - 16
6801-LL-10-10	7/8 - 14	7/8 - 14
6801-LL-12-12	1-1/16 - 12	1-1/16 - 12
6801-LL-12-16	1-1/16 - 12	1-5/16 - 12
6801-LL-16-12	1-5/16 - 12	1-1/16 - 12
6801-LL-16-16	1-5/16 - 12	1-5/16 - 12
6801-LL-20-20	1-5/8 - 12	1-5/8 - 12

6801LLL ...JIC - ORB 90° XX LONG ELBOW

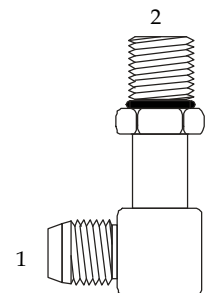

(1) (2)	MALE JIC	MALE ORB
6801-LLL-04-04	7/16 - 20	7/16 - 20
6801-LLL-06-06	9/16 - 18	9/16 - 18
6801-LLL-06-08	9/16 - 18	9/16 - 18
6801-LLL-08-08	3/4 - 16	3/4 - 16
6801-LLL-10-10	7/8 - 14	7/8 - 14
6801-LLL-12-12	1-1/16 - 12	1-1/16 - 12
6801-LLL-16-16	1-5/16 - 12	1-5/16 - 12

JIC 37° FLARE ADAPTERS

6802 ...JIC to ORB 45° ELBOW

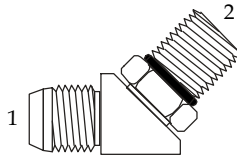

(1) (2)	MALE JIC	MALE ORB
6802-02-02	5/16-24	5/16-24
6802-04-04	7/16-20	7/16-20
6802-04-05	7/16-20	1/2-20
6802-04-06	7/16-20	9/16-18
6802-04-08	7/16-20	3/4-16
6802-05-04	1/2-20	7/16-20
6802-05-05	1/2-20	1/2-20
6802-05-06	1/2-20	9/16-18
6802-06-04	9/16-18	7/16-20
6802-06-05	9/16-18	1/2-20
6802-06-06	9/16-18	9/16-18
6802-06-08	9/16-18	3/4-16
6802-06-10	9/16-18	7/8-14
6802-08-04	3/4-16	7/16-20
6802-08-06	3/4-16	9/16-18
6802-08-08	3/4-16	3/4-16
6802-08-10	3/4-16	7/8-14
6802-08-12	3/4-16	1-1/16-12
6802-10-08	7/8-14	3/4-16
6802-10-10	7/8-14	7/8-14
6802-10-12	7/8-14	1-1/16-12
6802-12-08	1-1/16-12	3/4-16
6802-12-10	1-1/16-12	7/8-14
6802-12-12	1-1/16-12	1-1/16-12
6802-12-16	1-1/16-12	1-5/16-12
6802-16-12	1-5/16-12	1-1/16-12
6802-16-16	1-5/16-12	1-5/16-12
6802-16-20	1-5/16-12	1-5/8-12
6802-20-16	1-5/8-12	1-5/16-12
6802-20-20	1-5/8-12	1-5/8-12
6802-20-24	1-5/8-12	1-7/8-12
6802-24-20	1-7/8-12	1-5/8-12
6802-24-24	1-7/8-12	1-7/8-12
6802-32-32	2-1/2-12	2-1/2-12

6803 ... JIC to ORB BRANCH TEE

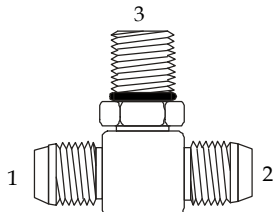

(1) (2) (3)	(1) (2) MALE JIC	(3) MALE ORB
6803-04-04-04	7/16-20	7/16-20
6803-04-04-06	7/16-20	9/16-18
6803-05-05-05	1/2-20	1/2-20
6803-06-06-04	9/16-18	7/16-20
6803-06-06-06	9/16-18	9/16-18
6803-06-06-08	9/16-18	3/4-16

...continued top of next page

...continued

6803-08-08-06	3/4-16	9/16-18
6803-08-08-08	3/4-16	3/4-16
6803-08-08-10	3/4-16	7/8-14
6803-10-10-08	7/8-14	3/4-16
6803-10-10-10	7/8-14	7/8-14
6803-10-10-12	7/8-14	1-1/16-12
6803-12-12-08	1-1/16-12	3/4-16
6803-12-12-10	1-1/16-12	7/8-14
6803-12-12-12	1-1/16-12	1-1/16-12
6803-12-12-16	1-1/16-12	1-5/16-12
6803-14-14-14	1-3/16-12	1-3/16-12
6803-16-16-12	1-5/16-12	1-1/16-12
6803-16-16-16	1-5/16-12	1-5/16-12
6803-20-20-20	1-5/8-12	1-5/8-12
6803-24-24-24	1-7/8-12	1-7/8-12
6803-32-32-32	2-1/2-12	2-1/2-12

6804 ...JIC to ORB RUN TEE

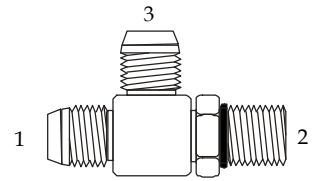

(1) (2) (3)	(1) MALE JIC	(2) MALE ORB	(3) MALE JIC
6804-04-04-04	7/16-20	7/16-20	7/16-20
6804-04-06-04	7/16-20	9/16-18	7/16-20
6804-04-06-06	7/16-20	9/16-18	9/16-18
6804-05-05-05	1/2-20	1/2-20	1/2-20
6804-06-04-06	9/16-18	7/16-20	9/16-18
6804-06-06-04	9/16-18	9/16-18	7/16-20
6804-06-06-06	9/16-18	9/16-18	9/16-18
6804-06-06-08	9/16-18	9/16-18	3/4-16
6804-06-08-06	9/16-18	3/4-16	9/16-18
6804-08-06-08	3/4-16	9/16-18	3/4-16
6804-08-08-08	3/4-16	3/4-16	3/4-16
6804-08-10-08	3/4-16	7/8-14	3/4-16
6804-08-12-08	3/4-16	1-1/16-12	3/4-16
6804-10-08-10	7/8-14	3/4-16	7/8-14
6804-10-10-10	7/8-14	7/8-14	7/8-14
6804-10-10-12	7/8-14	7/8-14	1-1/16-12
6804-10-12-10	7/8-14	1-1/16-12	7/8-14
6804-12-10-12	1-1/16-12	7/8-14	1-1/16-12
6804-12-12-12	1-1/16-12	1-1/16-12	1-1/16-12
6804-12-12-16	1-1/16-12	1-1/16-12	1-5/16-12
6804-14-14-14	1-3/16-12	1-3/16-12	1-3/16-12
6804-16-12-16	1-5/16-12	1-1/16-12	1-5/16-12
6804-16-16-16	1-5/16-12	1-5/16-12	1-5/16-12
6804-20-20-20	1-5/8-12	1-5/8-12	1-5/8-12
6804-24-24-24	1-7/8-12	1-7/8-12	1-7/8-12
6804-32-32-32	2-1/2-12	2-1/2-12	2-1/2-12

JIC 37° FLARE ADAPTERS

6805 ...ORB to PIPE 90° ELBOW

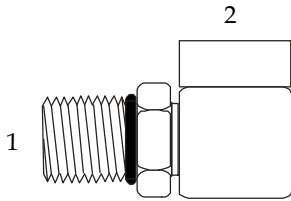

(1) (2)	MALE ORB	FEMALE PIPE
6805-02-04	5/16 - 24	1/4" - 18
6805-04-02	7/16 - 20	1/8" - 27
6805-04-04	7/16 - 20	1/4" - 18
6805-05-02	1/2 - 20	1/8" - 27
6805-06-04	9/16 - 18	1/4" - 18
6805-06-06	9/16 - 18	3/8" - 18
6805-08-06	3/4 - 16	3/8" - 18
6805-08-08	3/4 - 16	1/2" - 14
6805-10-06	7/8 - 14	3/8" - 18
6805-10-08	7/8 - 14	1/2" - 14
6805-12-08	1-1/16 - 12	1/2" - 14
6805-12-12	1-1/16 - 12	3/4" - 14
6805-16-12	1-5/16 - 12	3/4" - 14
6805-16-16	1-5/16 - 12	1" - 11-1/2
6805-20-20	1-5/8 - 12	1-1/4" - 11-1/2
6805-24-24	1-7/8 - 12	1-1/2" - 11-1/2
6805-32-32	2-1/2 - 12	2" - 11-1/2

6806 ...ORB to PIPE CONNECTOR

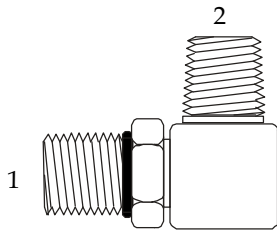

(1) (2)	MALE ORB	MALE PIPE
6806-04-02	7/16 - 20	1/8" - 27
6806-04-04	7/16 - 20	1/4" - 18
6806-05-02	1/2 - 20	1/8" - 27
6806-06-04	9/16 - 18	1/4" - 18
6806-06-06	9/16 - 18	3/8" - 18
6806-08-06	3/4 - 16	3/8" - 18
6806-08-08	3/4 - 16	1/2" - 14
6806-10-08	7/8 - 14	1/2" - 14
6806-12-12	1-1/16 - 12	3/4" - 14
6806-12-16	1-1/16 - 12	1" - 11-1/2
6806-14-12	1-3/16 - 12	3/4" - 14
6806-16-12	1-5/16 - 12	3/4" - 14
6806-16-16	1-5/16 - 12	1" - 11-1/2
6806-20-20	1-5/8 - 12	1-1/4" - 11-1/2
6806-24-24	1-7/8 - 12	1-1/2" - 11-1/2
6806-32-32	2-1/2 - 12	2" - 11-1/2

6807 ... ORB 90° ELBOW

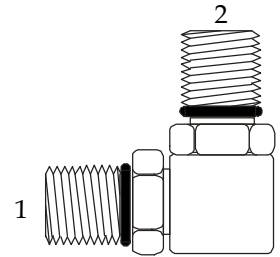

(1) (2)	(1) MALE ORB	(2) MALE ORB
6807-04-04	7/16 - 20	7/16 - 20
6807-06-06	9/16 - 18	9/16 - 18
6807-08-08	3/4 - 16	3/4 - 16
6807-10-10	7/8 - 14	7/8 - 14
6807-12-12	1-1/16 - 12	1-1/16 - 12
6807-16-16	1-5/16 - 12	1-5/16 - 12

6809 ... ORB to JIC SWIVEL 90° ELBOW

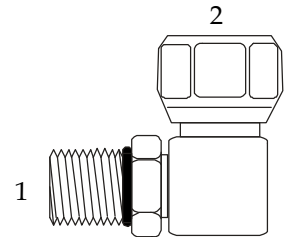

(1) (2)	MALE ORB	FEMALE JIC
6809-04-04	7/16 - 20	7/16 - 20
6809-06-04	9/16 - 18	7/16 - 20
6809-06-06	9/16 - 18	9/16 - 18
6809-08-06	3/4 - 16	9/16 - 18
6809-08-08	3/4 - 16	3/4 - 16
6809-10-10	7/8 - 14	7/8 - 14
6809-12-08	1-1/16 - 12	3/4 - 16
6809-12-12	1-1/16 - 12	1-1/16 - 12
6809-16-16	1-5/16 - 12	1-5/16 - 12
6809-20-20	1-5/8 - 12	1-5/8 - 12
6809-24-24	1-7/8 - 12	1-7/8 - 12

O-RING BOSS ADAPTERS

Detailed Sizes on the following pages.

3474



(1)(2) Male ORB Bulkhead

6400

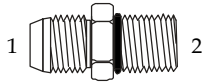

(1) Male JIC
(2) Male ORB

6400-L

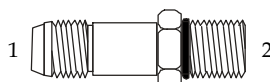

(1) Male JIC
(2) Male ORB LONG

6401

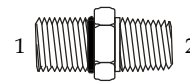

(1) Male ORB
(2) Male NPT

6402

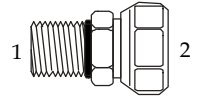

(1) Male ORB
(2) Female JIC

6404

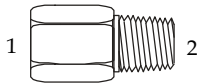

(1) Female ORB
(2) Male NPT

6405

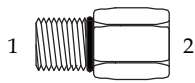

(1) Male ORB
(2) Female NPT

6408

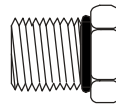

ORB Plug

6408-H

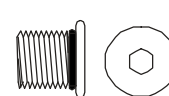

ORB Sunken Hex Plug

6410

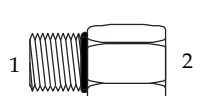

(1) Male ORB
(2) Female ORB

6801

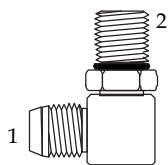

(1) Male JIC
(2) Male ORB

6801-L

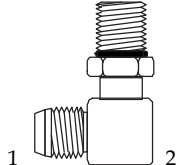

(1) Male JIC
(2) Male ORB Long

6801-LL

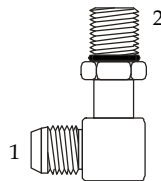

(1) Male JIC
(2) Male ORB X Long

6801-LLL

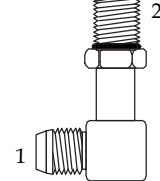

(1) Male JIC
(2) Male ORB XX Long

6802

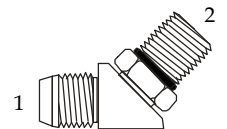

(1) Male JIC
(2) Male ORB

6803

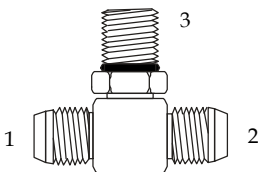

(1)(2) Male JIC
(3) Male ORB

6804

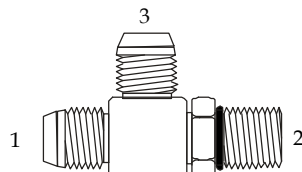

(1)(3) Male JIC
(2) Male ORB

6805

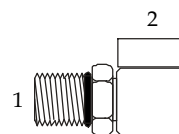

(1) Male ORB
(2) Female NPT

6806

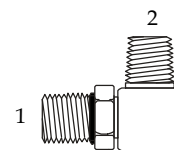

(1) Male ORB
(2) Male NPT

6807

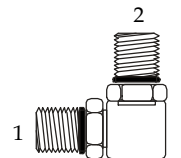

(1)(2) Male ORB

6808

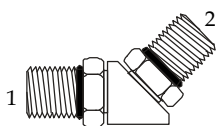

(1)(2) Male ORB

6809

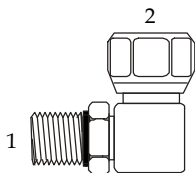

(1) Male ORB
(2) Female JIC SWIVEL

6900

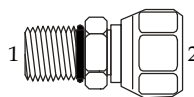

(1) Male ORB
(2) Female NPT

6901

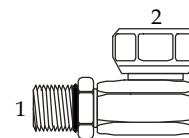

(1) Male ORB
(2) Female NPT

6902

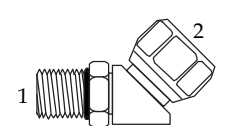

(1) Male ORB
(2) Female NPT

O-RING BOSS ADAPTERS

3474 ...O-RING MALE ADJUSTABLE UNION

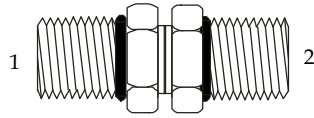

(1) (2)	(1) (2) MALE ORB
3474-04-04	7/16 - 20
3474-06-06	9/16 - 18
3474-08-08	3/4 - 16
3474-10-10	7/8 - 14
3474-12-12	1-1/16 - 12
3474-16-16	1-5/16 - 12
3474-20-20	1-5/8 - 12
3474-24-24	1-7/8 - 12
3474-32-32	2-1/2 - 12

6400 ...JIC - O-RING CONNECTOR

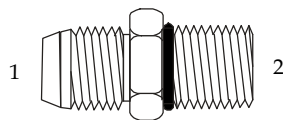

(1) (2)	MALE JIC	MALE ORB
6400-02-02	5/16 - 24	5/16 - 24
6400-03-03	3/8 - 24	3/8 - 24
6400-04-02	7/16 - 20	5/16 - 24
6400-04-03	7/16 - 20	3/8 - 24
6400-04-04	7/16 - 20	7/16 - 20
6400-04-05	7/16 - 20	1/2 - 20
6400-04-06	7/16 - 20	9/16 - 18
6400-04-08	7/16 - 20	3/4 - 16
6400-04-10	7/16 - 20	7/8 - 14
6400-04-12	7/16 - 20	1-1/16 - 12
6400-05-04	1/2 - 20	7/16 - 20
6400-05-05	1/2 - 20	1/2 - 20
6400-05-06	1/2 - 20	9/16 - 18
6400-05-08	1/2 - 20	3/4 - 16
6400-05-10	1/2 - 20	7/8 - 14
6400-06-04	9/16 - 18	7/16 - 20
6400-06-05	9/16 - 18	1/2 - 20
6400-06-06	9/16 - 18	9/16 - 18
6400-06-08	9/16 - 18	3/4 - 16
6400-06-10	9/16 - 18	7/8 - 14
6400-06-12	9/16 - 18	1-1/16 - 12
6400-06-16	9/16 - 18	1-5/16 - 12
6400-08-04	3/4 - 16	7/16 - 20
6400-08-05	3/4 - 16	1/2 - 20
6400-08-06	3/4 - 16	9/16 - 18
6400-08-08	3/4 - 16	3/4 - 16
6400-08-10	3/4 - 16	7/8 - 14
6400-08-12	3/4 - 16	1-1/16 - 12
6400-08-16	3/4 - 16	1-5/16 - 12

...continued

(1) (2)	MALE JIC	MALE ORB
6400-10-04	7/8 - 14	7/16 - 20
6400-10-06	7/8 - 14	9/16 - 18
6400-10-08	7/8 - 14	3/4 - 16
6400-10-10	7/8 - 14	7/8 - 14
6400-10-12	7/8 - 14	1-1/16 - 12
6400-10-16	7/8 - 14	1-5/16 - 12
6400-10-20	7/8 - 14	1-5/8 - 16
6400-12-06	1-1/16 - 12	9/16 - 18
6400-12-08	1-1/16 - 12	3/4 - 16
6400-12-10	1-1/16 - 12	7/8 - 14
6400-12-12	1-1/16 - 12	1-1/16 - 12
6400-12-14	1-1/16 - 12	1-3/16 - 12
6400-12-16	1-1/16 - 12	1-5/16 - 12
6400-12-20	1-1/16 - 12	1-5/8 - 16
6400-12-24	1-1/16 - 12	1-7/8 - 12
6400-14-08	1-3/16 - 12	3/4 - 16
6400-14-10	1-3/16 - 12	7/8 - 14
6400-14-12	1-3/16 - 12	1-1/16 - 12
6400-14-14	1-3/16 - 12	1-3/16 - 12
6400-14-16	1-3/16 - 12	1-5/16 - 12
6400-16-08	1-5/16 - 12	3/4 - 16
6400-16-10	1-5/16 - 12	7/8 - 14
6400-16-12	1-5/16 - 12	1-1/16 - 12
6400-16-14	1-5/16 - 12	1-3/16 - 12
6400-16-16	1-5/16 - 12	1-5/16 - 12
6400-16-20	1-5/16 - 12	1-5/8 - 12
6400-16-24	1-5/16 - 12	1-7/8 - 12
6400-20-12	1-5/8 - 12	1-1/16 - 12
6400-20-16	1-5/8 - 12	1-5/16 - 12
6400-20-20	1-5/8 - 12	1-5/8 - 12
6400-20-24	1-5/8 - 12	1-7/8 - 12
6400-24-16	1-7/8 - 12	1-5/16 - 12
6400-24-20	1-7/8 - 12	1-5/8 - 12
6400-24-24	1-7/8 - 12	1-7/8 - 12
6400-24-32	2-1/2 - 12	2-1/2 - 12
6400-32-24	1-7/8 - 12	1-7/8 - 12
6400-32-32	2-1/2 - 12	2-1/2 - 12

ORB ... O-RING BOSS (ORB) O-RINGS

	O-RING I.D.	O-RING I.D.
ORB-2	.239"	ORB-12 924"
ORB-3	.301"	ORB-14 1.048"
ORB-4	.351"	ORB-16 1.171"
ORB-5	.414"	ORB-20 1.475"
ORB-6	.468"	ORB-24 1.720"
ORB-8	.644"	ORB-32 2.337"
ORB-10	.755"	

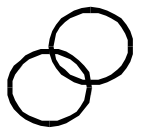

...continued top of next column

O-RING BOSS ADAPTERS

6400L ...JIC - ORB LONG CONNECTOR

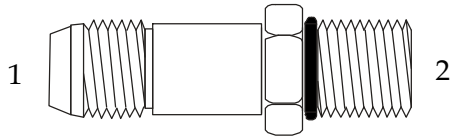

(1) (2)	MALE JIC	MALE ORB
6400-L-04-04	7/16 - 20	7/16 - 20
6400-L-05-05	1/2 - 20	1/2 - 20
6400-L-06-06	9/16 - 18	9/16 - 18
6400-L-08-08	3/4 - 16	3/4 - 16
6400-L-10-10	7/8 - 14	7/8 - 14
6400-L-12-12	1-1/16 - 12	1-1/16 - 12
6400-L-16-16	1-5/16 - 12	1-5/16 - 12
6400-L-20-20	1-5/8 - 12	1-5/8 - 12

6402 ...MALE ORB - FEMALE JIC SWIVEL

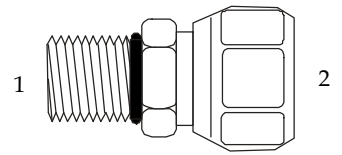

(1) (2)	MALE ORB	FEMALE JIC
6402-04-04	7/16 - 20	7/16 - 20
6402-06-06	9/16 - 18	9/16 - 18
6402-08-08	3/4 - 16	3/4 - 16
6402-10-10	7/8 - 14	7/8 - 14
6402-12-12	1-1/16 - 12	1-1/16 - 12
6402-16-16	1-5/16 - 12	1-5/16 - 12
6402-20-20	1-5/8 - 12	1-5/8 - 12

6401 ...ORB - PIPE CONNECTOR

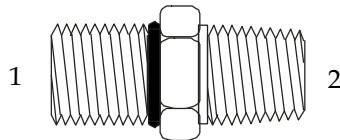

(1) (2)	MALE ORB	MALE PIPE
6401-04-02	7/16 - 20	1/8" - 27
6401-04-04	7/16 - 20	1/4" - 18
6401-04-06	7/16 - 20	3/8" - 18
6401-05-02	1/2 - 20	1/8" - 27
6401-05-04	1/2 - 20	1/4" - 18
6401-06-02	9/16 - 18	1/8" - 27
6401-06-04	9/16 - 18	1/4" - 18
6401-06-06	9/16 - 18	3/8" - 18
6401-06-08	9/16 - 18	1/2" - 14
6401-08-04	3/4 - 16	1/4" - 18
6401-08-06	3/4 - 16	3/8" - 18
6401-08-08	3/4 - 16	1/2" - 14
6401-08-12	3/4 - 16	3/4" - 14
6401-10-04	7/8 - 14	1/4" - 18
6401-10-06	7/8 - 14	3/8" - 18
6401-10-08	7/8 - 14	1/2" - 14
6401-10-12	7/8 - 14	3/4" - 14
6401-12-06	1-1/16 - 12	3/8" - 18
6401-12-08	1-1/16 - 12	1/2" - 14
6401-12-12	1-1/16 - 12	3/4" - 14
6401-12-16	1-1/16 - 12	1" - 11-1/2
6401-16-12	1-5/16 - 12	3/4" - 14
6401-16-16	1-5/16 - 12	1" - 11-1/2
6401-16-20	1-5/16 - 12	1-1/4" - 11-1/2
6401-20-12	1-5/8 - 12	3/4" - 14
6401-20-16	1-5/8 - 12	1" - 11-1/2
6401-20-20	1-5/8 - 12	1-1/4" - 11-1/2
6401-24-16	1-7/8 - 12	1" - 11-1/2
6401-24-20	1-7/8 - 12	1-1/4" - 11-1/2
6401-24-24	1-7/8 - 12	1-1/2" - 11-1/2
	2-1/2 - 12	2" - 11-1/2

6404 ...FEMALE ORB - PIPE CONNECTOR

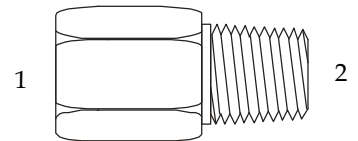

(1) (2)	FEMALE ORB	MALE PIPE
6404-04-02	7/16 - 20	1/8" - 27
6404-04-04	7/16 - 20	1/4" - 18
6404-04-06	7/16 - 20	3/8" - 18
6404-05-02	1/2 - 20	1/8" - 27
6404-05-04	1/2 - 20	1/4" - 18
6404-06-04	9/16 - 18	1/4" - 18
6404-06-06	9/16 - 18	3/8" - 18
6404-06-08	9/16 - 18	1/2" - 14
6404-08-04	3/4 - 16	1/4" - 18
6404-08-06	3/4 - 16	3/8" - 18
6404-08-08	3/4 - 16	1/2" - 14
6404-08-12	3/4 - 16	3/4" - 14
6404-10-06	7/8 - 14	3/8" - 18
6404-10-08	7/8 - 14	1/2" - 14
6404-10-12	7/8 - 14	3/4" - 14
6404-12-08	1-1/16 - 12	1/2" - 14
6404-12-12	1-1/16 - 12	3/4" - 14
6404-14-12	1-3/16 - 12	3/4" - 14
6404-16-12	1-5/16 - 12	3/4" - 14
6404-16-16	1-5/16 - 12	1" - 11-1/2
6404-20-20	1-5/8 - 12	1-1/4" - 11-1/2
6404-24-24	1-7/8 - 12	1-1/2" - 11-1/2
	2-1/2 - 12	2" - 11-1/2

O-RING BOSS ADAPTERS

6405 ...ORB - FEMALE PIPE CONNECTOR

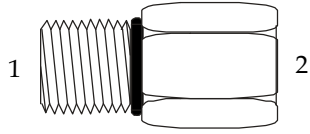

(1) (2)	MALE ORB	FEMALE PIPE
6405-02-02	5/16 - 24	1/8" - 27
6405-02-04	5/16 - 24	1/4" - 18
6405-03-04	3/8 - 24	1/4" - 18
6405-04-02	7/16 - 20	1/8" - 27
6405-04-04	7/16 - 20	1/4" - 18
6405-04-06	7/16 - 20	3/8" - 18
6405-05-02	1/2 - 20	1/8" - 27
6405-05-04	1/2 - 20	1/4" - 18
6405-05-06	1/2 - 20	3/8" - 18
6405-06-02	9/16 - 18	1/8" - 27
6405-06-04	9/16 - 18	1/4" - 18
6405-06-06	9/16 - 18	3/8" - 18
6405-06-08	9/16 - 18	1/2" - 14
6405-08-02	3/4 - 16	1/8" - 27
6405-08-04	3/4 - 16	1/4" - 18
6405-08-06	3/4 - 16	3/8" - 18
6405-08-08	3/4 - 16	1/2" - 14
6405-08-12	3/4 - 16	3/4" - 14
6405-10-04	7/8 - 14	1/4" - 18
6405-10-06	7/8 - 14	3/8" - 18
6405-10-08	7/8 - 14	1/2" - 14
6405-10-12	7/8 - 14	3/4" - 14
6405-12-04	1-1/16 - 12	1/4" - 18
6405-12-06	1-1/16 - 12	3/8" - 18
6405-12-08	1-1/16 - 12	1/2" - 14
6405-12-12	1-1/16 - 12	3/4" - 14
6405-12-16	1-1/16 - 12	1" - 11-1/2
6405-14-12	1-3/16 - 12	3/4" - 14
6405-14-16	1-3/16 - 12	1" - 11-1/2
6405-16-04	1-5/16 - 12	1/4" - 18
6405-16-06	1-5/16 - 12	3/8" - 18
6405-16-08	1-5/16 - 12	1/2" - 14
6405-16-12	1-5/16 - 12	3/4" - 14
6405-16-16	1-5/16 - 12	1" - 11-1/2
6405-16-20	1-5/16 - 12	1-1/4" - 11-1/2
6405-16-24	1-5/16 - 12	1-1/2" - 11-1/2
6405-20-08	1-5/8 - 12	1/2" - 14
6405-20-12	1-5/8 - 12	3/4" - 14
6405-20-16	1-5/8 - 12	1" - 11-1/2
6405-20-20	1-5/8 - 12	1-1/4" - 11-1/2
6405-20-24	1-5/8 - 12	1-1/2" - 11-1/2
6405-20-32	1-5/8 - 12	2" - 11-1/2
6405-24-12	1-7/8 - 12	3/4" - 14
6405-24-16	1-7/8 - 12	1" - 11-1/2
6405-24-20	1-7/8 - 12	1-1/4" - 11-1/2
6405-24-24	1-7/8 - 12	1-1/2" - 11-1/2
6405-32-16	2-1/2 - 12	1" - 11-1/2
6405-32-20	2-1/2 - 12	1-1/4" - 11-1/2
6405-32-24	2-1/2 - 12	1-1/2" - 11-1/2
6405-32-32	2-1/2 - 12	2" - 11-1/2

6408 ...O-RING HEX PLUG

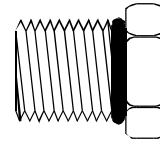

	MALE ORB
6408-02	5/16 - 24
6408-03	3/8 - 24
6408-04	7/16 - 20
6408-05	1/2 - 20
6408-06	9/16 - 18
6408-08	3/4 - 16
6408-10	7/8 - 14
6408-12	1-1/16 - 12
6408-14	1-3/16 - 12
6408-16	1-5/16 - 12
6408-20	1-5/8 - 12
6408-24	1-7/8 - 12
6408-32	2-1/2 - 12

6408H ...O-RING HOLLOW HEX PLUG

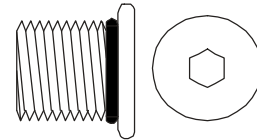

	MALE ORB
6408-HHP-02	5/16 - 24
6408-HHP-03	3/8 - 24
6408-HHP-04	7/16 - 20
6408-HHP-05	1/2 - 20
6408-HHP-06	9/16 - 18
6408-HHP-08	3/4 - 16
6408-HHP-10	7/8 - 14
6408-HHP-12	1-1/16 - 12
6408-HHP-14	1-3/16 - 12
6408-HHP-16	1-5/16 - 12
6408-HHP-20	1-5/8 - 12
6408-HHP-24	1-7/8 - 12
6408-HHP-32	2-1/2 - 12

O-RING BOSS ADAPTERS

6410 ...ORB REDUCER/ EXPANDER

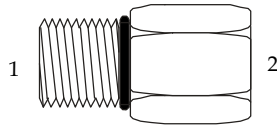

(1) (2)	MALE ORB	FEMALE ORB
6410-02-04	5/16 -24	7/16 -20
6410-03-04	3/8 - 24	7/16 -20
6410-04-03	7/16 -20	3/8 -24
6410-04-04	7/16 -20	7/16 -20
6410-04-05	7/16 -20	1/2 -20
6410-04-06	7/16 -20	9/16 -18
6410-04-08	7/16 -20	3/4 -16
6410-05-04	1/2 -20	7/16 -20
6410-05-06	1/2 -20	9/16 -18
6410-06-04	9/16 -18	7/16 -20
6410-06-06	9/16 -18	9/16 -18
6410-06-08	9/16 -18	3/4 -16
6410-08-04	3/4 -16	7-16 -20
6410-08-06	3/4 -16	9/16 -18
6410-08-08	3/4 -16	3/4 -16
6410-08-10	3/4 -16	7/8 -14
6410-08-12	3/4 -16	1-1/16 -12
6410-10-04	7/8 -14	7/16 -20
6410-10-05	7/8 -14	1/2 -20
6410-10-06	7/8 -14	9/16 -18
6410-10-08	7/8 -14	3/4 -16
6410-10-12	7/8 -14	1-1/16 -12
6410-12-04	1-1/16 -12	7/16 -20
6410-12-06	1-1/16 -12	9/16 -18
6410-12-08	1-1/16 -12	3/4 -16
6410-12-10	1-1/16 -12	7/8 -14
6410-12-12	1-1/16 -12	1-1/16 -12
6410-12-14	1-1/16 -12	1-3/16 -12
6410-12-16	1-1/16 -12	1-5/16 -12
6410-12-20	1-1/16 -12	1-5/8 -12
6410-14-10	1-3/16 -12	7/8 -14
6410-14-12	1-3/16 -12	1-1/16 -12
6410-14-16	1-3/16 -12	1-5/16 -12
6410-16-04	1-5/16 -12	7-16 -20
6410-16-06	1-5/16 -12	9/16 -18
6410-16-08	1-5/16 -12	3/4 -16
6410-16-10	1-5/16 -12	7/8 -14
6410-16-12	1-5/16 -12	1-1/16 -12
6410-16-14	1-5/16 -12	1-3/16 -12
6410-16-20	1-5/16 -12	1-5/8 -12
6410-16-24	1-5/16 -12	1-7/8 -12
6410-20-06	1-5/8 -12	9/16 -18
6410-20-08	1-5/8 -12	3/4 -16
6410-20-10	1-5/8 -12	7/8 -14
6410-20-12	1-5/8 -12	1-1/16 -12
6410-20-16	1-5/8 -12	1-5/16 -12
6410-20-24	1-5/8 -12	1-7/8 -12
6410-24-12	1-7/8 -12	1-1/16 -12
6410-24-16	1-7/8 -12	1-5/16 -12
6410-24-20	1-7/8 -12	1-5/8 -12
6410-32-12	2-1/2 -12	1-1/16 -12
6410-32-16	2-1/2 -12	1-5/16 -12
6410-32-20	2-1/2 -12	1-5/8 -12
6410-32-24	2-1/2 -12	1-7/8 -12

6801 ...JIC - ORB 90° ELBOW

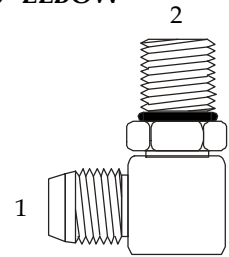

(1) (2)	MALE JIC	MALE ORB
6801-02-02	5/16 -24	5/16 -24
6801-02-04	5/16 -24	7/16 -20
6801-03-03	3/8 -24	3/8 -24
6801-03-04	3/8 -24	7/16 -20
6801-04-02	7/16 -20	5/16 -24
6801-04-03	7/16 -20	3/8 -24
6801-04-04	7/16 -20	7/16 -20
6801-04-05	7/16 -20	1/2 -20
6801-04-06	7/16 -20	9/16 -18
6801-04-08	7/16 -20	3/4 -16
6801-05-04	1/2 -20	7/16 -20
6801-05-05	1/2 -20	1/2 -20
6801-05-06	1/2 -20	9/16 -18
6801-05-08	1/2 -20	3/4 -16
6801-05-10	1/2 -20	7/8 -14
6801-06-04	9/16 -18	7/16 -20
6801-06-05	9/16 -18	1/2 -20
6801-06-06	9/16 -18	9/16 -18
6801-06-08	9/16 -18	3/4 -16
6801-06-10	9/16 -18	7/8 -14
6801-06-12	9/16 -18	1-1/16 -12
6801-08-04	3/4 -16	7/16 -20
6801-08-05	3/4 -16	1/2 -20
6801-08-06	3/4 -16	9/16 -18
6801-08-08	3/4 -16	3/4 -16
6801-08-10	3/4 -16	7/8 -14
6801-08-12	3/4 -16	1-1/16 -12
6801-08-16	3/4 -16	1-5/16 -12
6801-10-06	7/8 -14	9/16 -18
6801-10-08	7/8 -14	3/4 -16
6801-10-10	7/8 -14	7/8 -14
6801-10-12	7/8 -14	1-1/16 -12
6801-10-16	7/8 -14	1-5/16 -12
6801-10-20	7/8 -14	1-5/8 -16
6801-12-06	1-1/16 -12	9/16 -18
6801-12-08	1-1/16 -12	3/4 -16
6801-12-10	1-1/16 -12	7/8 -14
6801-12-12	1-1/16 -12	1-1/16 -12
6801-12-14	1-1/16 -12	1-3/16 -12
6801-12-16	1-1/16 -12	1-5/16 -12
6801-12-20	1-1/16 -12	1-5/8 -12
6801-14-12	1-3/16 -12	1-1/16 -12
6801-14-14	1-3/16 -12	1-3/16 -12
6801-14-16	1-3/16 -12	1-5/16 -12

...continued top of next page

O-RING BOSS ADAPTERS

...continued from previous page

(1) (2)	MALE JIC	MALE ORB
6801-16-08	1-5/16 - 12	3/4 - 16
6801-16-10	1-5/16 - 12	7/8 - 14
6801-16-12	1-5/16 - 12	1-1/16 - 12
6801-16-14	1-5/16 - 12	1-3/16 - 12
6801-16-16	1-5/16 - 12	1-5/16 - 12
6801-16-20	1-5/16 - 12	1-5/8 - 12
6801-16-24	1-5/16 - 12	1-7/8 - 12
6801-20-12	1-5/8 - 12	1-1/16 - 12
6801-20-14	1-5/8 - 12	1-3/16 - 12
6801-20-16	1-5/8 - 12	1-5/16 - 12
6801-20-20	1-5/8 - 12	1-5/8 - 12
6801-20-24	1-5/8 - 12	1-7/8 - 12
6801-24-16	1-7/8 - 12	1-5/16 - 12
6801-24-20	1-7/8 - 12	1-5/8 - 12
6801-24-24	1-7/8 - 12	1-7/8 - 12
6801-24-32	1-7/8 - 12	2-1/2 - 12
6801-32-24	2-1/2 - 12	1-7/8 - 12
6801-32-32	2-1/2 - 12	2-1/2 - 12

6801L ...JIC - ORB 90° LONG ELBOW

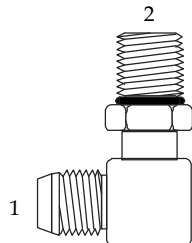

(1) (2)	MALE JIC	MALE ORB
6801-L-04-04	7/16 - 20	7/16 - 20
6801-L-06-06	9/16 - 18	9/16 - 18
6801-L-06-08	9/16 - 18	3/4 - 16
6801-L-08-06	3/4 - 16	9/16 - 18
6801-L-08-08	3/4 - 16	3/4 - 16
6801-L-08-10	3/4 - 16	7/8 - 14
6801-L-10-08	7/8 - 14	3/4 - 16
6801-L-10-10	7/8 - 14	7/8 - 14
6801-L-10-12	7/8 - 14	1-1/16 - 12
6801-L-12-10	1-1/16 - 12	7/8 - 14
6801-L-12-12	1-1/16 - 12	1-1/16 - 12
6801-L-16-12	1-5/16 - 12	1-1/16 - 12
6801-L-16-16	1-5/16 - 12	1-5/16 - 12
6801-L-20-20	1-5/8 - 12	1-5/8 - 12

6801LL ...JIC - ORB 90° X LONG ELBOW

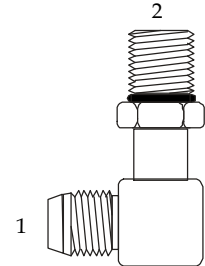

(1) (2)	MALE JIC	MALE ORB
6801-LL-04-04	7/16 - 20	7/16 - 20
6801-LL-04-06	7/16 - 20	9/16 - 18
6801-LL-06-06	9/16 - 18	9/16 - 18
6801-LL-06-08	9/16 - 18	3/4 - 16
6801-LL-08-06	3/4 - 16	9/16 - 18
6801-LL-08-08	3/4 - 16	3/4 - 16
6801-LL-08-10	3/4 - 16	7/8 - 14
6801-LL-10-08	7/8 - 14	3/4 - 16
6801-LL-10-10	7/8 - 14	7/8 - 14
6801-LL-12-12	1-1/16 - 12	1-1/16 - 12
6801-LL-12-16	1-1/16 - 12	1-5/16 - 12
6801-LL-16-12	1-5/16 - 12	1-1/16 - 12
6801-LL-16-16	1-5/16 - 12	1-5/16 - 12
6801-LL-20-20	1-5/8 - 12	1-5/8 - 12

6801LLL ...JIC - ORB 90° XX LONG ELBOW

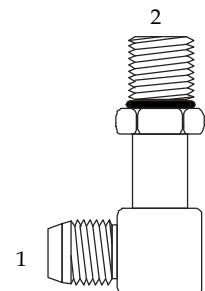

(1) (2)	MALE JIC	MALE ORB
6801-LLL-04-04	7/16 - 20	7/16 - 20
6801-LLL-06-06	9/16 - 18	9/16 - 18
6801-LLL-06-08	9/16 - 18	9/16 - 18
6801-LLL-08-08	3/4 - 16	3/4 - 16
6801-LLL-10-10	7/8 - 14	7/8 - 14
6801-LLL-12-12	1-1/16 - 12	1-1/16 - 12
6801-LLL-16-16	1-5/16 - 12	1-5/16 - 12

O-RING BOSS ADAPTERS

6802 ...JIC to ORB 45° ELBOW

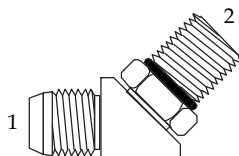

(1) (2)	MALE JIC	MALE ORB
6802-02-02	5/16-24	5/16-24
6802-04-04	7/16-20	7/16-20
6802-04-05	7/16-20	1/2-20
6802-04-06	7/16-20	9/16-18
6802-04-08	7/16-20	3/4-16
6802-05-04	1/2-20	7/16-20
6802-05-05	1/2-20	1/2-20
6802-05-06	1/2-20	9/16-18
6802-06-04	9/16-18	7/16-20
6802-06-05	9/16-18	1/2-20
6802-06-06	9/16-18	9/16-18
6802-06-08	9/16-18	3/4-16
6802-06-10	9/16-18	7/8-14
6802-08-04	3/4-16	7/16-20
6802-08-06	3/4-16	9/16-18
6802-08-08	3/4-16	3/4-16
6802-08-10	3/4-16	7/8-14
6802-08-12	3/4-16	1-1/16-12
6802-10-08	7/8-14	3/4-16
6802-10-10	7/8-14	7/8-14
6802-10-12	7/8-14	1-1/16-12
6802-12-08	1-1/16-12	3/4-16
6802-12-10	1-1/16-12	7/8-14
6802-12-12	1-1/16-12	1-1/16-12
6802-12-16	1-1/16-12	1-5/16-12
6802-16-12	1-5/16-12	1-1/16-12
6802-16-16	1-5/16-12	1-5/16-12
6802-16-20	1-5/16-12	1-5/8-12
6802-20-16	1-5/8-12	1-5/16-12
6802-20-20	1-5/8-12	1-5/8-12
6802-20-24	1-5/8-12	1-7/8-12
6802-24-20	1-7/8-12	1-5/8-12
6802-24-24	1-7/8-12	1-7/8-12
6802-32-32	2-1/2-12	2-1/2-12

6803 ... JIC to ORB BRANCH TEE

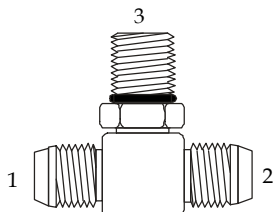

(1) (2) (3)	(1) (2) MALE JIC	(3) MALE ORB
6803-04-04-04	7/16-20	7/16-20
6803-04-04-06	7/16-20	9/16-18
6803-05-05-05	1/2-20	1/2-20
6803-06-06-04	9/16-18	7/16-20
6803-06-06-06	9/16-18	9/16-18
6803-06-06-08	9/16-18	3/4-16

...continued top of next page

...continued

6803-08-08-06	3/4-16	9/16-18
6803-08-08-08	3/4-16	3/4-16
6803-08-08-10	3/4-16	7/8-14
6803-10-10-08	7/8-14	3/4-16
6803-10-10-10	7/8-14	7/8-14
6803-10-10-12	7/8-14	1-1/16-12
6803-12-12-08	1-1/16-12	3/4-16
6803-12-12-10	1-1/16-12	7/8-14
6803-12-12-12	1-1/16-12	1-1/16-12
6803-12-12-16	1-1/16-12	1-5/16-12
6803-14-14-14	1-3/16-12	1-3/16-12
6803-16-16-12	1-5/16-12	1-1/16-12
6803-16-16-16	1-5/16-12	1-5/16-12
6803-20-20-20	1-5/8-12	1-5/8-12
6803-24-24-24	1-7/8-12	1-7/8-12
6803-32-32-32	2-1/2-12	2-1/2-12

6804 ... JIC to ORB RUN TEE

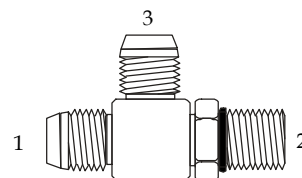

(1) (2) (3)	(1) MALE JIC	(2) MALE ORB	(3) MALE JIC
6804-04-04-04	7/16-20	7/16-20	7/16-20
6804-04-06-04	7/16-20	9/16-18	7/16-20
6804-04-06-06	7/16-20	9/16-18	9/16-18
6804-05-05-05	1/2-20	1/2-20	1/2-20
6804-06-04-06	9/16-18	7/16-20	9/16-18
6804-06-06-04	9/16-18	9/16-18	7/16-20
6804-06-06-06	9/16-18	9/16-18	9/16-18
6804-06-06-08	9/16-18	9/16-18	3/4-16
6804-06-08-06	9/16-18	3/4-16	9/16-18
6804-08-06-08	3/4-16	9/16-18	3/4-16
6804-08-08-08	3/4-16	3/4-16	3/4-16
6804-08-10-08	3/4-16	7/8-14	3/4-16
6804-08-12-08	3/4-16	1-1/16-12	3/4-16
6804-10-08-10	7/8-14	3/4-16	7/8-14
6804-10-10-10	7/8-14	7/8-14	7/8-14
6804-10-10-12	7/8-14	7/8-14	1-1/16-12
6804-10-12-10	7/8-14	1-1/16-12	7/8-14
6804-12-10-12	1-1/16-12	7/8-14	1-1/16-12
6804-12-12-12	1-1/16-12	1-1/16-12	1-1/16-12
6804-12-12-16	1-1/16-12	1-1/16-12	1-5/16-12
6804-14-14-14	1-3/16-12	1-3/16-12	1-3/16-12
6804-16-12-16	1-5/16-12	1-1/16-12	1-5/16-12
6804-16-16-16	1-5/16-12	1-5/16-12	1-5/16-12
6804-20-20-20	1-5/8-12	1-5/8-12	1-5/8-12
6804-24-24-24	1-7/8-12	1-7/8-12	1-7/8-12
6804-32-32-32	2-1/2-12	2-1/2-12	2-1/2-12

O-RING BOSS ADAPTERS

6805 ...ORB to PIPE 90° ELBOW

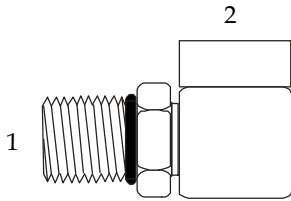

(1) (2)	MALE ORB	FEMALE PIPE
6805-02-04	5/16 - 24	1/4" - 18
6805-04-02	7/16 - 20	1/8" - 27
6805-04-04	7/16 - 20	1/4" - 18
6805-05-02	1/2 - 20	1/8" - 27
6805-06-04	9/16 - 18	1/4" - 18
6805-06-06	9/16 - 18	3/8" - 18
6805-08-06	3/4 - 16	3/8" - 18
6805-08-08	3/4 - 16	1/2" - 14
6805-10-06	7/8 - 14	3/8" - 18
6805-10-08	7/8 - 14	1/2" - 14
6805-12-08	1-1/16 - 12	1/2" - 14
6805-12-12	1-1/16 - 12	3/4" - 14
6805-16-12	1-5/16 - 12	3/4" - 14
6805-16-16	1-5/16 - 12	1" - 11-1/2
6805-20-20	1-5/8 - 12	1-1/4" - 11-1/2
6805-24-24	1-7/8 - 12	1-1/2" - 11-1/2
6805-32-32	2-1/2 - 12	2" - 11-1/2

6806 ...ORB to PIPE CONNECTOR

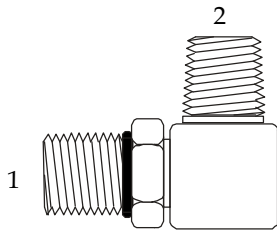

(1) (2)	MALE ORB	MALE PIPE
6806-04-02	7/16 - 20	1/8" - 27
6806-04-04	7/16 - 20	1/4" - 18
6806-05-02	1/2 - 20	1/8" - 27
6806-06-04	9/16 - 18	1/4" - 18
6806-06-06	9/16 - 18	3/8" - 18
6806-08-06	3/4 - 16	3/8" - 18
6806-08-08	3/4 - 16	1/2" - 14
6806-10-08	7/8 - 14	1/2" - 14
6806-12-12	1-1/16 - 12	3/4" - 14
6806-12-16	1-1/16 - 12	1" - 11-1/2
6806-14-12	1-3/16 - 12	3/4" - 14
6806-16-12	1-5/16 - 12	3/4" - 14
6806-16-16	1-5/16 - 12	1" - 11-1/2
6806-20-20	1-5/8 - 12	1-1/4" - 11-1/2
6806-24-24	1-7/8 - 12	1-1/2" - 11-1/2
6806-32-32	2-1/2 - 12	2" - 11-1/2

6807 ... ORB 90° ELBOW

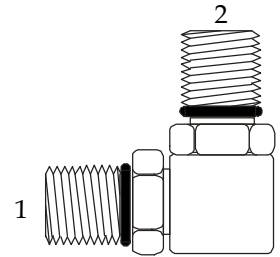

(1) (2)	(1) MALE ORB	(2) MALE ORB
6807-04-04	7/16 - 20	7/16 - 20
6807-06-06	9/16 - 18	9/16 - 18
6807-08-08	3/4 - 16	3/4 - 16
6807-10-10	7/8 - 14	7/8 - 14
6807-12-12	1-1/16 - 12	1-1/16 - 12
6807-16-16	1-5/16 - 12	1-5/16 - 12

6809 ... ORB to JIC SWIVEL 90° ELBOW

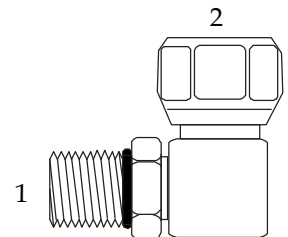

(1) (2)	MALE ORB	FEMALE JIC
6809-04-04	7/16 - 20	7/16 - 20
6809-06-04	9/16 - 18	7/16 - 20
6809-06-06	9/16 - 18	9/16 - 18
6809-08-06	3/4 - 16	9/16 - 18
6809-08-08	3/4 - 16	3/4 - 16
6809-10-10	7/8 - 14	7/8 - 14
6809-12-08	1-1/16 - 12	3/4 - 16
6809-12-12	1-1/16 - 12	1-1/16 - 12
6809-16-16	1-5/16 - 12	1-5/16 - 12
6809-20-20	1-5/8 - 12	1-5/8 - 12
6809-24-24	1-7/8 - 12	1-7/8 - 12

O-RING BOSS ADAPTERS

6900 ...ORB to PIPE SWIVEL

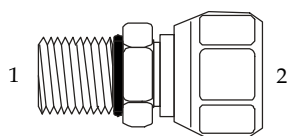

(1) (2)	MALE ORB	FEMALE PIPESWIVEL
Ø900-04-02	7/16 - 20	1/8" - 27
Ø900-04-04	7/16 - 20	1/4" - 18
Ø900-04-06	7/16 - 20	3/8" - 18
Ø900-04-08	7/16 - 20	1/2" - 14
Ø900-05-04	1/2 - 20	1/4" - 18
Ø900-05-08	1/2 - 20	1/2" - 14
Ø900-06-04	9/16 - 18	1/4" - 18
Ø900-06-06	9/16 - 18	3/8" - 18
Ø900-06-08	9/16 - 18	1/2" - 14
Ø900-08-04	3/4 - 16	1/4" - 18
Ø900-08-06	3/4 - 16	3/8" - 18
Ø900-08-08	3/4 - 16	1/2" - 14
Ø900-08-12	3/4 - 16	3/4" - 14
Ø900-10-06	7/8 - 14	3/8" - 18
Ø900-10-08	7/8 - 14	1/2" - 14
Ø900-10-12	7/8 - 14	3/4" - 14
Ø900-12-06	1-1/16 - 12	3/8" - 18
Ø900-12-08	1-1/16 - 12	1/2" - 14
Ø900-12-12	1-1/16 - 12	3/4" - 14
Ø900-12-16	1-1/16 - 12	1" - 11-1/2
Ø900-14-12	1-3/16 - 12	3/4" - 14
Ø900-14-16	1-3/16 - 12	1" - 11-1/2
Ø900-16-08	1-5/16 - 12	1/2" - 14
Ø900-16-12	1-5/16 - 12	3/4" - 14
Ø900-16-16	1-5/16 - 12	1" - 11-1/2
Ø900-16-20	1-5/16 - 12	1-1/4" - 11-1/2
Ø900-20-12	1-5/8 - 12	3/4" - 14
Ø900-20-16	1-5/8 - 12	1" - 11-1/2
Ø900-20-20	1-5/8 - 12	1-1/4" - 11-1/2
Ø900-24-20	1-7/8 - 12	1-1/2" - 11-1/2
Ø900-24-24	1-7/8 - 12	1-1/2" - 11-1/2
Ø900-32-32	2-1/2 - 12	2" - 11-1/2

ORB ... O-RING BOSS (ORB) O-RINGS

O-RING I.D.	ORB-#	O-RING I.D.
239"	ORB-2	.924"
301"	ORB-3	.1048"
351"	ORB-4	.1171"
414"	ORB-5	.1475"
468"	ORB-6	.1720"
644"	ORB-8	.2337"
755"	ORB-10	

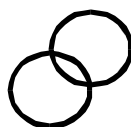

6901 ...ORB to PIPE SWIVEL LONG 90°

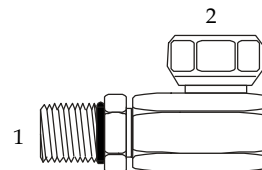

(1) (2)	MALE ORB	FEMALE PIPESWIVEL
6901-04-04	7/16 - 20	1/4" - 18
6901-04-06	7/16 - 20	3/8" - 18
6901-04-08	7/16 - 20	1/2" - 14
6901-06-04	7/16 - 20	1/4" - 18
6901-06-06	9/16 - 18	3/8" - 18
6901-06-08	9/16 - 18	1/2" - 14
6901-08-04	3/4 - 16	1/4" - 18
6901-08-06	3/4 - 16	3/8" - 18
6901-08-08	3/4 - 16	1/2" - 14
6901-08-12	3/4 - 16	3/4" - 14
6901-10-04	7/8 - 14	1/4" - 18
6901-10-06	7/8 - 14	3/8" - 18
6901-10-08	7/8 - 14	1/2" - 14
6901-10-12	7/8 - 14	3/4" - 14
6901-12-06	1-1/16 - 12	3/8" - 18
6901-12-08	1-1/16 - 12	1/2" - 14
6901-12-12	1-1/16 - 12	3/4" - 14
6901-12-16	1-1/16 - 12	1" - 11-1/2
6901-14-12	1-3/16 - 12	3/4" - 14
6901-14-16	1-3/16 - 12	1" - 11-1/2
6901-16-12	1-5/16 - 12	3/4" - 14
6901-16-16	1-5/16 - 12	1" - 11-1/2
6901-16-20	1-5/16 - 12	1-1/4" - 11-1/2
6901-20-12	1-5/8 - 12	3/4" - 14
6901-20-16	1-5/8 - 12	1" - 11-1/2
6901-20-20	1-5/8 - 12	1-1/4" - 11-1/2
6901-24-24	1-7/8 - 12	1-1/2" - 11-1/2
6901-32-32	2-1/2 - 12	2" - 11-1/2

6902 ...ORB to PIPE SWIVEL 45° ELBOW

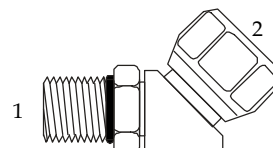

(1) (2)	MALE ORB	FEMALE PIPE SWIVEL
6902-04-04	7/16 - 20	1/4" - 18
6902-04-06	7/16 - 20	3/8" - 18
6902-06-04	9/16 - 18	1/4" - 18
6902-06-06	9/16 - 18	3/8" - 18
6902-06-08	9/16 - 18	1/2" - 14
6902-08-04	3/4 - 16	1/4" - 18
6902-08-06	3/4 - 16	3/8" - 18
6902-08-08	3/4 - 16	1/2" - 14
6902-08-12	3/4 - 16	3/4" - 14
6902-10-06	7/8 - 14	3/8" - 18
6902-10-08	7/8 - 14	1/2" - 14
6902-10-12	7/8 - 14	3/4" - 14
6902-12-06	1-1/16 - 12	3/8" - 18
6902-12-08	1-1/16 - 12	1/2" - 14
6902-12-12	1-1/16 - 12	3/4" - 14
6902-12-16	1-1/16 - 12	1" - 11-1/2
6902-16-12	1-5/16 - 12	3/4" - 14
6902-16-16	1-5/16 - 12	1" - 11-1/2
6902-20-16	1-5/8 - 12	1" - 11-1/2
6902-20-20	1-5/8 - 12	1-1/4" - 11-1/2
6902-24-24	1-7/8 - 12	1-1/2" - 11-1/2

O-RING FACE SEAL ADAPTERS

Detailed Sizes on the following pages.

FS 304

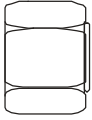

ORFS Cap

FS 306

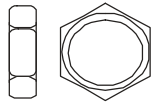

Bulkhead Lock Nut

FS 318

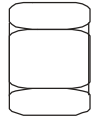

Tube Nut

FS 319

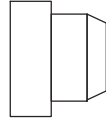

Tube Sleeve

FS 403

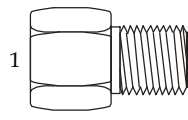

(1) Bore
(2) Male Face Seal

FS 2403

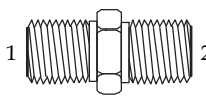

(1) Male Face Seal
(2) Male Face Seal

FS 2404

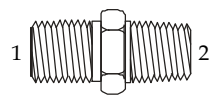

(1) Male Face Seal
(2) Male NPT

FS 2406

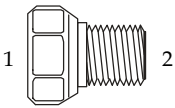

(1) Female Face Seal
(2) Male Face Seal

FS 2408

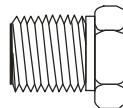

Male Face Seal Plug

FS 2500

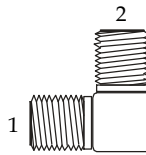

(1) Male Face Seal
(2) Male Face Seal

FS 2501

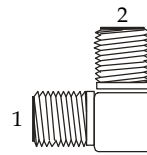

(1) Male Face Seal
(2) Male NPT

FS 2503

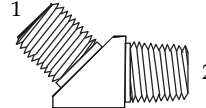

(1) Male Face Seal
(2) Male NPT

FS 2601

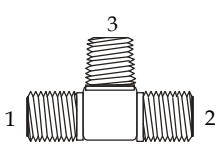

(1)(2) Male Face Seal
(3) Male NPT

FS 2603

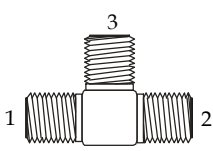

(1)(2)(3)
Male Face Seal

FS 2650

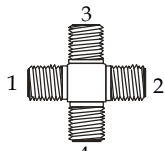

(1)(2)(3)(4)
Male Face Seal

FS 2700

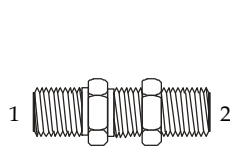

(1) Male Face Seal
(2) Face Seal Bulkhead

FS 2701

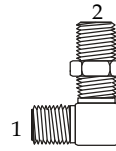

(1) Male Face Seal
(2) Face Seal Bulkhead

FS 2702

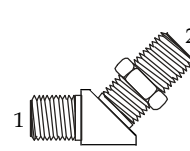

(1) Male Face Seal
(2) Male Face Seal

FS 2703

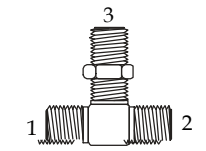

(1)(2) Male Face Seal
(3) Face Seal Bulkhead

FS 2704

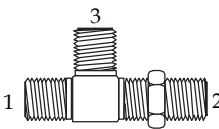

(1)(3) Male Face Seal
(2) Male Face Seal Bulkhead

FS 6400

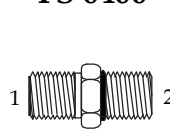

(1) Male Face Seal
(2) Male ORB

FS 6400-L

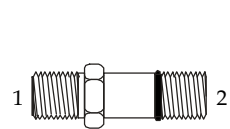

(1) Male Face Seal
(2) Male ORB Long

FS 6402

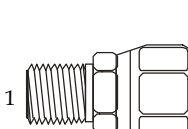

(1) Male Face Seal
(2) Female JIC

FS 6403

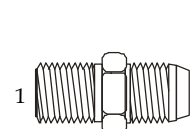

(1) Male Face Seal
(2) Male JIC

FS 6500

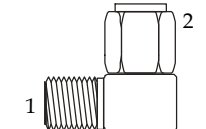

(1) Male Face Seal
(2) Female Face Seal

FS 6502

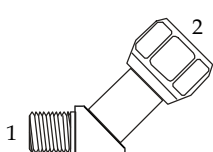

(1) Male Face Seal
(2) Female JIC

FS 6503

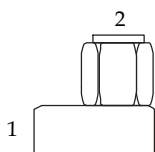

(1) Female NPT
(2) Female Face Seal

FS 6504

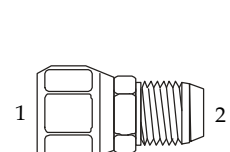

(1) Female Face Seal
(2) Male JIC

FS 6505

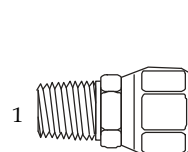

(1) Male NPT
(2) Female Face Seal

FS 6600

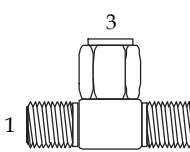

(1)(2) Male Face Seal
(3) Female Face Seal

FS 6602

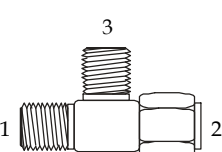

(1)(3) Male Face Seal
(2) Female Face Seal

FS 6801

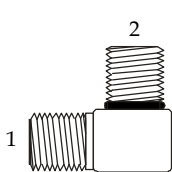

(1) Male Face Seal
(2) Male Adj. ORB

FS 6801-L

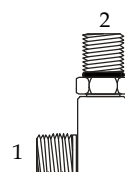

(1) Male Face Seal
(2) Male Adj. ORB

FS 6802

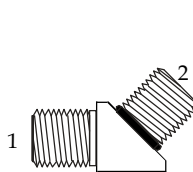

(1) Male Face Seal
(2) Male Adj. ORB

FS 6803

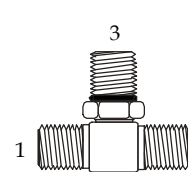

(1)(2) Male Face Seal
(3) Male Adj. ORB

FS 6804

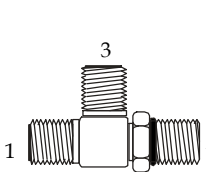

(1)(3) Male Face Seal
(2) Male Adj. ORB

FS 6809

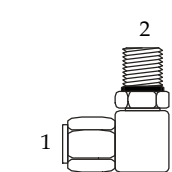

(1) Female Face Seal
(2) Male Adj. ORB

O-RING FACE SEAL ADAPTERS

FS304C ...ORFS CAP

	THREAD
FS304C-04	9/16 - 18
FS304C-06	11/16 - 16
FS304C-08	13/16 - 16
FS304C-10	1 - 14
FS304C-12	1-3/16 - 12
FS304C-16	1-7/16 - 12
FS304C-20	1-11/16 - 12
FS304C-24	2 - 12

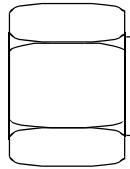

FS306 ...ORFS BULKHEAD LOCK NUT

	THREAD
FS306-04	9/16-18
FS306-06	11/16-16
FS306-08	13/16-16
FS306-10	1-14
FS306-12	1-3/16-12
FS306-16	1-7/16-12
FS306-20	1-11/16-12
FS306-24	2-12

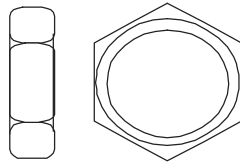

FS318 ...ORFS NUT

	THREAD
FS318-04	9/16-18
FS318-06	11/16-16
FS318-08	13/16-16
FS318-10	1-14
FS318-12	1-3/16-12
FS318-16	1-7/16-12
FS318-20	1-11/16-12
FS318-24	2-12

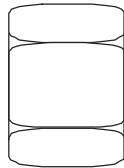

FS319 ...ORFS SLEEVE

	TUBE O.D.
FS319-04	1/4"
FS319-06	3/8"
FS319-08	1/2"
FS319-10	5/8"
FS319-12	3/4"
FS319-16	1"
FS319-20	1-1/4"
FS319-24	1-1/2"

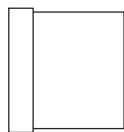

FS403 ...BORE-MFS STRAIGHT

	(1) BORE	(2) MALE ORFS
FS403-04-04	0.256	9/16-18
FS403-06-06	0.381	11/16-16
FS403-08-08	0.506	13/16-16
FS403-10-10	0.631	1-14
FS403-12-12	0.757	1-3/16-12
FS403-16-16	1.007	1-7/16-12
FS403-20-20	1.258	1-11/16-12
FS403-24-24	1.508	2-12

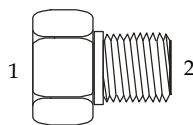

FS2403 ...ORFS MALE UNION

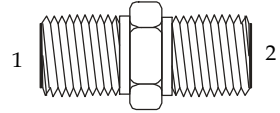

	(1) (2) MALE ORFS	MALE ORFS
FS2403-04-04	9/16-18	9/16-18
FS2403-06-04	11/16-16	9/16-18
FS2403-06-06	11/16-16	11/16-16
FS2403-08-06	13/16-16	11/16-16
FS2403-08-08	13/16-16	13/16-16
FS2403-10-08	1-14	13/16-16
FS2403-10-10	1-14	1-14
FS2403-12-08	1-3/16-12	13/16-12
FS2403-12-10	1-3/16-12	1-14
FS2403-12-12	1-3/16-12	1-3/16-12
FS2403-16-12	1-7/16-12	1-3/16-12
FS2403-16-16	1-7/16-12	1-7/16-12
FS2403-20-20	1-11/16-12	1-11/16-12
FS2403-24-24	2-12	2-12

FS2404 ...ORFS - MALE PIPE

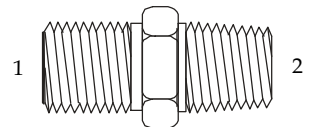

	(1) (2) MALE ORFS	MALE PIPE
FS2404-04-02	9/16-18	1/8"-27
FS2404-04-04	9/16-18	1/4"-18
FS2404-04-06	9/16-18	3/8"-18
FS2404-04-08	9/16-18	1/2"-14
FS2404-06-02	11/16-16	1/8"-27
FS2404-06-04	11/16-16	1/4"-18
FS2404-06-06	11/16-16	3/8"-18
FS2404-06-08	11/16-16	1/2"-14
FS2404-08-04	13/16-16	1/4"-18
FS2404-08-06	13/16-16	3/8"-18
FS2404-08-08	13/16-16	1/2"-14
FS2404-08-12	13/16-16	3/4"-14
FS2404-08-16	13/16-16	1"-11-1/2
FS2404-10-08	1-14	1/2"-14
FS2404-10-12	1-14	3/4"-14
FS2404-10-16	1-14	1"-11-1/2
FS2404-12-08	1-3/16-12	1/2"-14
FS2404-12-12	1-3/16-12	3/4"-14
FS2404-12-16	1-3/16-12	1"-11-1/2
FS2404-16-12	1-7/16-12	3/4"-14
FS2404-16-16	1-7/16-12	1"-11-1/2
FS2404-16-20	1-7/16-12	1-1/4"-11-1/2
FS2404-20-20	1-11/16-12	1-1/4"-11-1/2
FS2404-24-24	2-12	1-1/2"-11-1/2

O-RING FACE SEAL ADAPTERS

FS2406 ...ORFS REDUCER/ EXPANDER

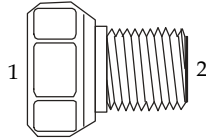

(1) (2)	FEMALE ORFS	MALE ORFS
FS2406-06-04	11/16-16	9/16-18
FS2406-06-06	11/16-16	11/16-16
FS2406-08-04	13/16-16	9/16-18
FS2406-08-06	13/16-16	11/16-16
FS2406-08-12	13/16-16	1-3/16-12
FS2406-10-04	1-14	9/16-18
FS2406-10-06	1-14	11/16-16
FS2406-10-08	1-14	13/16-16
FS2406-12-04	1-3/16-12	9/16-18
FS2406-12-06	1-3/16-12	11/16-16
FS2406-12-08	1-3/16-12	13/16-16
FS2406-12-10	1-3/16-12	1-14
FS2406-12-16	1-3/16-12	1-7/16-12
FS2406-16-08	1-7/16-12	13/16-16
FS2406-16-10	1-7/16-12	1-14
FS2406-16-12	1-7/16-12	1-3/16-12
FS2406-16-20	1-7/16-12	1-11/16-12
FS2406-20-12	1-11/16-12	1-3/16-12
FS2406-20-16	1-11/16-12	1-7/16-12
FS2406-20-24	1-11/16-12	2-12
FS2406-24-16	2-12	1-7/16-12
FS2406-24-20	2-12	1-11/16-12

FS2408 ...ORFS HEX PLUG

	MALE ORFS
FS2408-04	9/16 - 18
FS2408-06	11/16 - 16
FS2408-08	13/16 - 16
FS2408-10	1 - 14
FS2408-12	1-3/16 - 12
FS2408-16	1-7/16 - 12
FS2408-20	1-11/16 - 12
FS2408-24	2 - 12

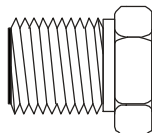

FS2500 ...ORFS 90° ELBOW

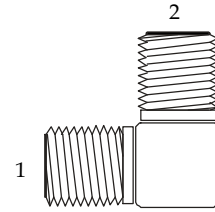

(1) (2)	MALE ORFS	MALE ORFS
FS2500-04-04	9/16-18	9/16-18
FS2500-06-06	11/16-16	11/16-16
FS2500-08-08	13/16-16	13/16-16
FS2500-10-10	1-14	1-14
FS2500-12-12	1-3/16-12	1-3/16-12
FS2500-16-16	1-7/16-12	1-7/16-12
FS2500-20-20	1-11/16-12	1-11/16-12
FS2500-24-24	2-12	2-12

FS2501 ...ORFS - PIPE 90° ELBOW

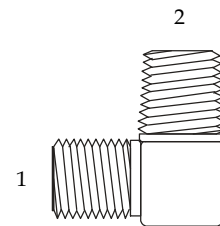

(1) (2)	MALE ORFS	MALE PIPE
FS2501-04-02	9/16-18	1/8"-27
FS2501-04-04	9/16-18	1/4"-18
FS2501-04-06	9/16-18	3/8"-18
FS2501-04-08	9/16-18	1/2"-14
FS2501-06-04	11/16-16	1/4"-18
FS2501-06-06	11/16-16	3/8"-18
FS2501-06-08	11/16-16	1/2"-14
FS2501-08-04	13/16-16	1/4"-18
FS2501-08-06	13/16-16	3/8"-18
FS2501-08-08	13/16-16	1/2"-14
FS2501-08-12	13/16-16	3/4"-14
FS2501-10-08	1-14	1/2"-14
FS2501-10-12	1-14	3/4"-14
FS2501-10-16	1-14	1"-11-1/2
FS2501-12-08	1-3/16-12	1/2"-14
FS2501-12-12	1-3/16-12	3/4"-14
FS2501-12-16	1-3/16-12	1"-11-1/2
FS2501-16-12	1-7/16-12	3/4"-14
FS2501-16-16	1-7/16-12	1"-11-1/2
FS2501-20-16	1-11/16-12	1"-11-1/2
FS2501-20-20	1-11/16-12	1-1/4"-11-1/2
FS2501-24-20	2-12	1-1/4"-11-1/2
FS2501-24-24	2-12	1-1/2"-11-1/2

O-RING FACE SEAL ADAPTERS

FS2503 ...ORFS - PIPE 45° ELBOW

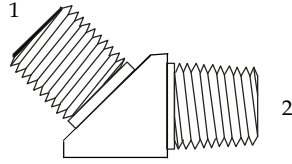

(1) (2)	MALE ORFS	MALE PIPE
FS2503-04-02	9/16-18	1/8"-27
FS2503-04-04	9/16-18	1/4"-18
FS2503-06-04	11/16-16	1/4"-18
FS2503-06-06	11/16-16	3/8"-18
FS2503-08-06	13/16-16	3/8"-18
FS2503-08-08	13/16-16	1/2"-14
FS2503-10-08	1-14	1/2"-14
FS2503-12-12	1-3/16-12	3/4"-14
FS2503-16-16	1-7/16-12	1"-11-1/2
FS2503-20-20	1-11/16-12	1-1/4"-11-1/2

FS2603 ...ORFS TEE

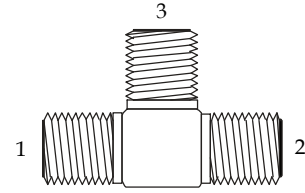

(1) (2) (3)	MALE ORFS	MALE ORFS	MALE ORFS
FS2603-04-04-04	9/16-18	9/16-18	9/16-18
FS2603-06-06-06	11/16-16	11/16-16	11/16-16
FS2603-06-06-08	11/16-16	11/16-16	13/16-16
FS2603-06-08-08	11/16-16	13/16-16	13/16-16
FS2603-08-06-08	13/16-16	11/16-16	13/16-16
FS2603-08-08-08	13/16-16	13/16-16	13/16-16
FS2603-10-10-10	1-14	1-14	1-14
FS2603-10-10-12	1-14	1-14	1-14
FS2603-12-12-04	1-3/16-12	1-3/16-12	9/16-18
FS2603-12-12-06	1-3/16-12	1-3/16-12	11/16-16
FS2603-12-12-12	1-3/16-12	1-3/16-12	1-3/16-12
FS2603-12-12-16	1-3/16-12	1-3/16-12	1-7/16-12
FS2603-16-16-12	1-7/16-12	1-7/16-12	1-3/16-12
FS2603-16-16-16	1-7/16-12	1-7/16-12	1-7/16-12
FS2603-20-20-16	1-11/16-12	1-11/16-12	1-7/16-12
FS2603-20-20-20	1-11/16-12	1-11/16-12	1-11/16-12
FS2603-24-24-24	2-12	2-12	2-12

FS2601 ...ORFS - PIPE BRANCH TEE

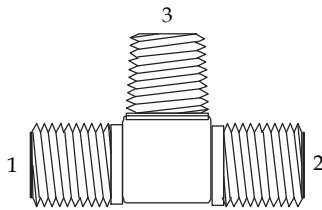

(1)(2)(3)	(1)(2) MALE ORFS	(3) MALE ORFS
FS2601-04-04-04	9/16-18	9/16-18
FS2601-06-06-04	11/16-16	9/16-18
FS2601-06-06-06	11/16-16	11/16-16
FS2601-08-08-06	13/16-16	11/16-16
FS2601-08-08-08	13/16-16	13/16-16
FS2601-12-12-12	1-3/16-12	1-3/16-12
FS2601-16-16-16	1-7/16-12	1-7/16-12
FS2601-20-20-20	1-11/16-12	1-11/16-12

FS2650 ...ORFS CROSS

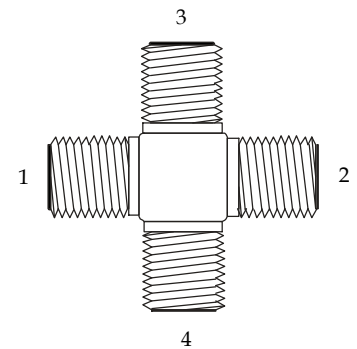

(1)(2)(3)(4)	MALE ORFS
FS2650-04-04-04-04	9/16-18
FS2650-06-06-06-06	11/16-16
FS2650-08-08-08-08	13/16-16
FS2650-10-10-10-10	1-14
FS2650-12-12-12-12	1-3/16-12
FS2650-16-16-16-16	1-7/16-12
FS2650-20-20-20-20	1-11/16-12
FS2650-24-24-24-24	2-12

O-RING FACE SEAL THREADS

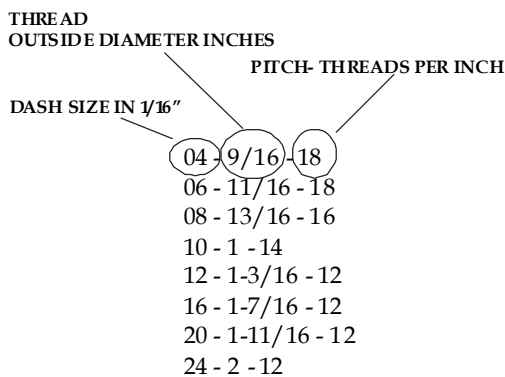

O-RING FACE SEAL ADAPTERS

FS2700 ...ORFS BULKHEAD

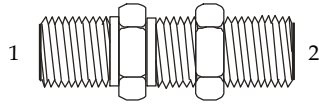

(1) (2)	MALE ORFS	MALE ORFS
FS2700-LN-04-04	9/16-18	9/16-18
FS2700-LN-06-06	11/16-16	11/16-16
FS2700-LN-08-08	13/16-16	13/16-16
FS2700-LN-10-10	1-14	1-14
FS2700-LN-12-12	1-3/16-12	1-3/16-12
FS2700-LN-16-16	1-7/16-12	1-7/16-12
FS2700-LN-20-20	1-11/16-12	1-11/16-12
FS2700-LN-24-24	2-12	2-12

FS2703 ...ORFS BULKHEAD UNION BRANCH TEE

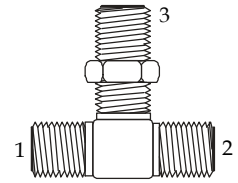

(1) (2) (3)	MALE ORFS
FS2703-04-04-04	9/16-18
FS2703-06-06-06	11/16-16
FS2703-08-08-08	13/16-16
FS2703-10-10-10	1-14
FS2703-12-12-12	1-3/16-12
FS2703-16-16-16	1-7/16-12
FS2703-20-20-20	1-11/16-12
FS2703-24-24-24	2-12

FS2701 ...ORFS BULKHEAD UNION 90°

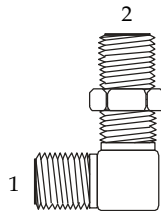

(1) (2)	MALE ORFS	MALE ORFS
FS2701-LN-04-04	9/16-18	9/16-18
FS2701-LN-06-06	11/16-16	11/16-16
FS2701-LN-08-08	13/16-16	13/16-16
FS2701-LN-08-10	13/16-16	1-14
FS2701-LN-10-10	1-14	1-14
FS2701-LN-12-12	1-3/16-12	1-3/16-12
FS2701-LN-16-16	1-7/16-12	1-7/16-12
FS2701-LN-20-20	1-11/16-12	1-11/16-12
FS2701-LN-24-24	2-12	2-12

FS2704 ...ORFS BULKHEAD UNION RUN TEE

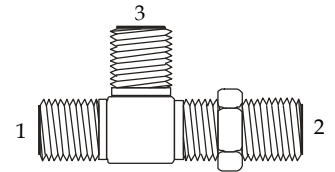

(1) (2) (3)	MALE ORFS
FS2703-04-04-04	9/16-18
FS2703-06-06-06	11/16-16
FS2703-08-08-08	13/16-16
FS2703-10-10-10	1-14
FS2703-12-12-12	1-3/16-12
FS2703-16-16-16	1-7/16-12
FS2703-20-20-20	1-11/16-12
FS2703-24-24-24	2-12

FS2702 ...ORFS BULKHEAD UNION 45°

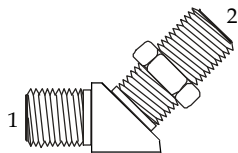

(1) (2)	MALE ORFS	MALE ORFS
FS2702-04-04	9/16-18	9/16-18
FS2702-06-06	11/16-16	11/16-16
FS2702-08-08	13/16-16	13/16-16
FS2702-10-10	1-14	1-14
FS2702-12-12	1-3/16-12	1-3/16-12
FS2702-16-16	1-7/16-12	1-7/16-12
FS2702-20-20	1-11/16-12	1-11/16-12
FS2702-24-24	2-12	2-12

O-RING FACE SEAL THREADS

THREAD	OUTSIDE DIAMETER INCHES	PITCH - THREADS PER INCH
04	9/16	18
06	11/16	16
08	13/16	16
10	1	14
12	1-3/16	12
16	1-7/16	12
20	1-11/16	12
24	2	12

O-RING FACE SEAL ADAPTERS

FS6400 ...ORFS to ORB

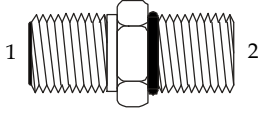

(1) (2)	MALE ORFS	MALE ORB
FS6400-04-04	9/16-18	7/16 - 20
FS6400-04-05	9/16-18	1/2-20
FS6400-04-06	9/16-18	9/16-18
FS6400-04-08	9/16-18	3/4-16
FS6400-06-03	11/16-18	7/16 - 20
FS6400-06-05	11/16-16	1/2 - 20
FS6400-06-06	11/16-16	9/16 - 18
FS6400-06-08	11/16-16	3/4-16
FS6400-06-10	11/16-16	7/8-14
FS6400-08-04	13/16-16	7/16-20
FS6400-08-06	13/16-16	9/16-18
FS6400-08-08	13/16-16	3/4 - 16
FS6400-08-10	13/16-16	7/8-14
FS6400-08-12	13/16-16	1-1/16 - 12
FS6400-08-16	13/16-16	1-5/16-12
FS6400-10-06	1-14	9/16-18
FS6400-10-08	1-14	3/4 - 16
FS6400-10-10	1-14	7/8-14
FS6400-10-12	1-14	1-1/16 - 12
FS6400-12-08	1-3/16-12	3/4 - 16
FS6400-12-10	1-3/16-12	7/8-14
FS6400-12-12	1-3/16-12	1-1/16 - 12
FS6400-12-16	1-3/16-12	1-5/16 - 12
FS6400-16-12	1-7/16-12	1-1/16 - 12
FS6400-16-16	1-7/16-12	1-5/16 - 12
FS6400-16-20	1-7/16-12	1-5/8 - 12
FS6400-20-16	1-11/16-12	1-5/16 - 12
FS6400-20-20	1-11/16-12	1-5/8-12
FS6400-20-24	1-11/16-12	1-7/8-12
FS6400-24-20	2-12	1-5/8-12
FS6400-24-24	2-12	1-7/8-12

FS6400 ...ORFS TO ORB LONG

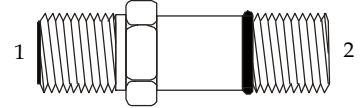

(1) (2)	MALE ORFS	MALE ORB
FS6400-04-04	9/16-18	7/16 - 20
FS6400-06-06	11/16-18	9/16 - 18
FS6400-08-08	13/16-16	3/4-16
FS6400-10-10	1-14	7/8-14
FS6400-12-12	1-3/16-12	1-1/16 - 12
FS6400-16-16	1-7/16-12	1-5/16-12
FS6400-20-20	1-11/16-12	1-5/8 - 12
FS6400-24-24	2-12	1-7/8-12

FS6402 ...ORFS - JIC SWIVEL

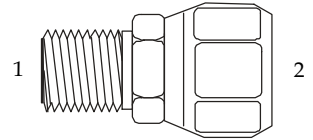

(1) (2)	MALE ORFS	FEMALE JIC
FS6402-04-04	9/16-18	7/16 - 20
FS6402-06-06	11/16-18	9/16 - 18
FS6402-08-08	13/16-16	3/4-16
FS6402-10-10	1-14	7/8-14
FS6402-12-12	1-3/16-12	1-1/16 - 12
FS6402-16-16	1-7/16-12	1-5/16-12
FS6402-20-20	1-11/16-12	1-5/8 - 12

FS6403 ...ORFS - MALE JIC

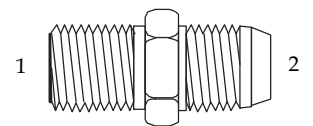

(1) (2)	MALE ORFS	MALE JIC
FS6403-04-04	9/16-18	9/16-18
FS6403-06-06	11/16-16	11/16-16
FS6403-08-08	13/16-16	13/16-16
FS6403-10-10	1-14	1-14
FS6403-12-12	1-3/16-12	1-3/16-12
FS6403-16-16	1-7/16-12	1-7/16-12
FS6403-20-20	1-11/16-12	1-11/16-12
FS6403-24-24	2-12	2-12

O-RING FACE SEAL THREADS

THREAD OUTSIDE DIAMETER INCHES	PITCH- THREADS PER INCH
04	9/16 - 18
06	11/16 - 18
08	13/16 - 16
10	1 - 14
12	1-3/16 - 12
16	1-7/16 - 12
20	1-11/16 - 12
24	2 - 12

DASH SIZE IN 1/16"

O-RING FACE SEAL ADAPTERS

FS6500 ...ORFS 90° ELBOW

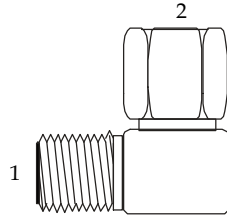

(1) (2)	MALE ORFS	FEMALE ORFS
FS6500-04-04	9/16-18	9/16-18
FS6500-04-06	9/16-18	11/16-16
FS6500-06-06	11/16-16	11/16-16
FS6500-08-06	13/16-16	11/16-16
FS6500-08-08	13/16-16	13/16-16
FS6500-08-12	13/16-16	1-3/16-12
FS6500-10-10	1-14	1-14
FS6500-12-12	1-3/16-12	1-3/16-12
FS6500-16-16	1-7/16-12	1-7/16-12
FS6500-20-20	1-11/16-12	1-11/16-12
FS6500-24-20	2-12	1-11/16-12
FS6500-24-24	2-12	2-12

FS6502 ...ORFS 45° ELBOW

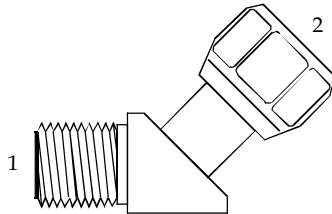

(1) (2)	MALE ORFS	FEMALE ORFS
FS6502-04-04	9/16 - 18	9/16 - 18
FS6502-06-06	11/16 - 16	11/16 - 16
FS6502-08-08	13/16 - 16	13/16 - 16
FS6502-10-10	1 - 14	1 - 14
FS6502-12-12	1-3/16 - 12	1-3/16 - 12
FS6502-16-16	1-7/16 - 12	1-7/16 - 12

FS6503 ...FEMALE PIPE - ORFS

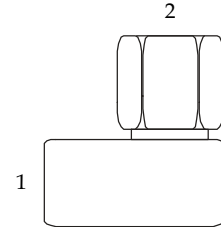

(1) (2)	FEMALE PIPE	FEMALE ORFS
FS6503-04-04	1/4-18	9/16-18
FS6503-06-06	3/8-18	11/16-16

FS6504 ...ORFS SWIVEL - MALE JIC

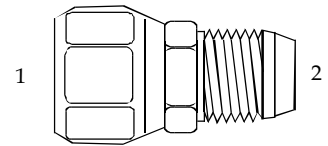

(1) (2)	FEMALE ORFS	MALE JIC
FS6504-04-04	9/16-18	9/16-18
FS6504-06-06	11/16-16	11/16-16
FS6504-08-04	13/16-16	9/16-18
FS6504-08-08	13/16-16	13/16-16
FS6504-10-10	1-14	1-14
FS6504-12-04	1-3/16-12	9/16-18
FS6504-12-12	1-3/16-12	1-3/16-12
FS6504-16-04	1-7/16-12	9/16-18
FS6504-16-16	1-7/16-12	1-7/16-12
FS6504-20-20	1-11/16-12	1-11/16-12
FS6504-24-24	2-12	2-12

FS6505 ...MALE PIPE - ORFS SWIVEL

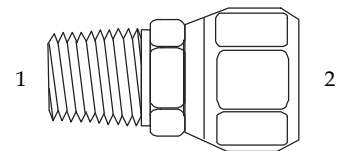

(1) (2)	MALE PIPE	FEMALE ORFS
FS6505-04-06	1/4-18	11/16-16

O-RING FACE SEAL ADAPTERS

FS6600 ...ORFS TO SWIVEL BRANCH TEE

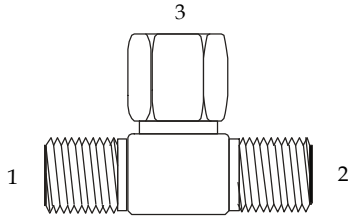

(1) (2) (3)	(1)(2)MALE ORFS	(3)FEMALE ORFS
FS6600-04-04-04	9/16-18	9/16-18
FS6600-06-06-06	11/16-16	11/16-16
FS6600-08-08-08	13/16-16	13/16-16
FS6600-10-10-10	1-14	1-14
FS6600-12-12-12	1-3/16-12	1-3/16-12
FS6600-16-16-16	1-7/16-12	1-7/16-12
FS6600-20-20-20	1-11/16-12	1-11/16-12
FS6600-24-24-24	2-12	2-12

FS6602 ...ORFS TO SWIVEL RUN TEE

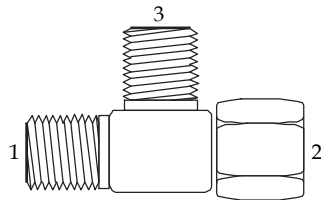

(1) (2) (3)	MALE ORFS	MALE ORFS	MALE ORFS
FS6602-04-04-04	9/16-18	9/16-18	9/16-18
FS6602-06-06-06	11/16-16	11/16-16	11/16-16
FS6602-06-06-08	11/16-16	11/16-16	13/16-16
FS6602-08-08-08	13/16-16	13/16-16	13/16-16
FS6602-10-10-10	1-14	1-14	1-14
FS6602-12-10-10	1-3/16-12	1-14	1-14
FS6602-12-12-10	1-3/16-12	1-3/16-12	1-14
FS6602-12-12-12	1-3/16-12	1-3/16-12	1-3/16-12
FS6602-16-16-16	1-7/16-12	1-7/16-12	1-7/16-12
FS6602-20-20-20	1-11/16-12	1-11/16-12	1-11/16-12
FS6602-24-24-24	2-12	2-12	2-12

FS6801 ... ORFS - MALE ORB 90° ELBOW

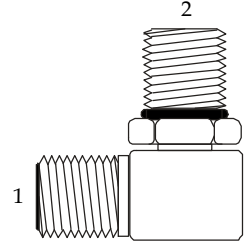

(1) (2)	MALE ORFS	MALE ORB
FS6801-04-04	9/16-18	7/16 - 20
FS6801-04-06	9/16-18	9/16-18
FS6801-04-08	9/16-18	3/4-16
FS6801-06-04	11/16-18	7/16 - 20
FS6801-06-05	11/16-16	1/2 - 20
FS6801-06-06	11/16-16	9/16 - 18
FS6801-06-08	11/16-16	3/4-16
FS6801-06-10	11/16-16	7/8-14
FS6801-06-12	11/16-16	1-1/16-12
FS6801-06-16	11/16-16	1-5/16-12
FS6801-08-06	13/16-16	9/16-18
FS6801-08-08	13/16-16	3/4 - 16
FS6801-08-10	13/16-16	7/8-14
FS6801-08-12	13/16-16	1-1/16 - 12
FS6801-10-08	1-14	3/4 - 16
FS6801-10-10	1-14	7/8-14
FS6801-10-12	1-14	1-1/16 - 12
FS6801-12-08	1-3/16-12	3/4 - 16
FS6801-12-10	1-3/16-12	7/8-14
FS6801-12-12	1-3/16-12	1-1/16 - 12
FS6801-12-16	1-3/16-12	1-5/16 - 12
FS6801-16-12	1-7/16-12	1-1/16 - 12
FS6801-16-14	1-7/16-12	1-3/16 - 12
FS6801-16-16	1-7/16-12	1-5/16 - 12
FS6801-16-20	1-7/16-12	1-5/8 - 12
FS6801-20-12	1-11/16-12	1-1/16 - 12
FS6801-20-16	1-11/16-12	1-5/16 - 12
FS6801-20-20	1-11/16-12	1-5/8-12
FS6801-20-24	1-11/16-12	1-7/8-12
FS6801-24-20	2-12	1-5/8-12
FS6801-24-24	2-12	1-7/8-12

FS6801-L ...ORFS - MALE ORB 90° LONG

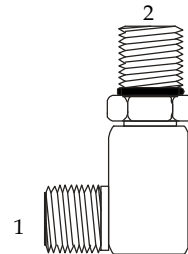

(1) (2)	MALE ORFS	MALE ORB
FS6801-L-04-04	9/16-18	7/16 - 20
FS6801-L-06-06	11/16-16	9/16-18
FS6801-L-08-08	13/16-16	3/4-16
FS6801-L-10-10	1-14	7/8-14
FS6801-L-12-12	1-3/16-12	1-1/16-12
FS6801-L-16-16	1-7/16-12	1-5/16-12

O-RING FACE SEAL ADAPTERS

FS6802 ...ORFS - ORB 45° ELBOW

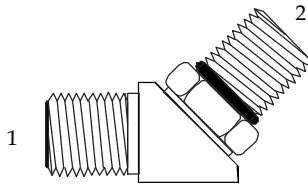

(1) (2)	MALE ORFS	MALE ORB
FS6802-04-03	9/16-18	3/8-24
FS6802-04-04	9/16-18	7/16 - 20
FS6802-04-06	9/16-18	9/16-18
FS6802-06-04	11/16-18	7/16 - 20
FS6802-06-06	11/16-16	9/16 - 18
FS6802-06-08	11/16-16	3/4-16
FS6802-06-10	11/16-16	7/8-14
FS6802-08-06	13/16-16	9/16-18
FS6802-08-08	13/16-16	3/4 - 16
FS6802-08-10	13/16-16	7/8-14
FS6802-08-12	13/16-16	1-1/16 - 12
FS6802-10-08	1-14	3/4 - 16
FS6802-10-10	1-14	7/8-14
FS6802-10-12	1-14	1-1/16 - 12
FS6802-12-08	1-3/16-12	3/4 - 16
FS6802-12-10	1-3/16-12	7/8-14
FS6802-12-12	1-3/16-12	1-1/16 - 12
FS6802-12-16	1-3/16-12	1-5/16 - 12
FS6802-16-12	1-7/16-12	1-1/16 - 12
FS6802-16-16	1-7/16-12	1-5/16 - 12
FS6802-16-20	1-7/16-12	1-5/8 - 12
FS6802-20-20	1-11/16-12	1-5/8-12
FS6802-24-24	2-12	1-7/8-12

FS6803 ...ORFS - ORB BRANCH TEE

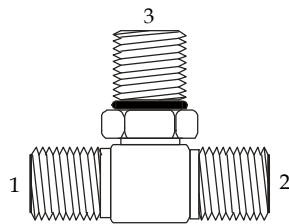

(1) (2) (3)	(1) (2) MALE ORFS	(3) MALE ORB
FS6803-04-04-04	9/16-18	7/16 - 20
FS6803-06-06-06	11/16-16	9/16-18
FS6803-06-06-08	11/16-16	3/4-16
FS6803-08-08-08	13/16-16	3/4 - 16
FS6803-10-10-10	1-14	7/8-14
FS6803-12-12-10	13/16-16	7/8-14
FS6803-12-12-12	13/16-16	1-1/16 - 12
FS6803-12-12-16	13/16-16	1-5/16 - 12
FS6803-16-16-16	1-7/16-12	1-5/16 - 12
FS6803-20-20-20	1-11/16-12	1-5/8-12
FS6803-24-24-24	2-12	1-7/8-12

FS6804 ...ORFS - ORB RUN TEE

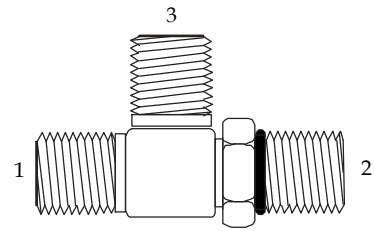

(1) (2) (3)	(1) MALE ORFS	(2) MALE ORB	(3) MALE ORFS
FS6804-04-04-04	9/16-18	7/16-20	9/16-18
FS6804-04-04-06	9/16-18	7/16-20	11/16-16
FS6804-04-06-04	9/16-18	9/16-18	9/16-18
FS6804-06-04-06	11/16-16	7/16-20	11/16-16
FS6804-06-06-06	11/16-16	9/16-18	11/16-16
FS6804-06-08-06	11/16-16	3/4-16	11/16-16
FS6804-08-06-08	13/16-16	9/16-18	13/16-16
FS6804-08-08-08	13/16-16	3/4-16	13/16-16
FS6804-08-10-08	13/16-16	7/8-14	13/16-16
FS6804-08-12-08	13/16-16	1-1/16-12	13/16-16
FS6804-10-10-10	1-14	7/8-14	1-14
FS6804-10-12-10	1-14	1-1/16-12	1-14
FS6804-12-12-12	1-3/16-12	1-1/16-12	1-3/16-12
FS6804-12-12-16	1-3/16-12	1-1/16-12	1-7/16-12
FS6804-16-16-16	1-7/16-12	1-5/16-12	1-7/16-12
FS6804-20-20-20	1-11/16-12	1-5/8-12	1-11/16-12
FS6804-24-24-24	2-12	1-7/8-12	2-12

FS6809 ...ORFS SWIVEL - MALE ORB 90°

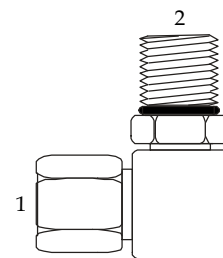

(1) (2)	FEMALE ORFS	MALE ORB
FS6809-04-04	9/16 - 18	7/16-20
FS6809-06-06	11/16 - 16	9/16-18
FS6809-08-08	13/16 - 16	3/4-16
FS6809-10-10	1 - 14	7/8-14
FS6809-12-12	1-3/16 - 12	1-1/16-12
FS6809-16-16	1-7/16 - 12	1-5/16-12
FS6809-20-20	1-11/16-12	1-5/8-12
FS6809-24-24	2-12	1-7/8-12

BSPP ADAPTERS

9033 ...BSPP CAP

Female BSPP Thread

9033-04	1/4-19
9033-06	3/8-19
9033-08	1/2-14
9033-10	5/8-14
9033-12	3/4-14
9033-16	1-11
9033-20	1-1/4-11

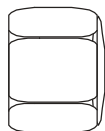

9030 ...BSPP HEX PLUG

BSPP Thread

9030-02	1/8-28
9030-04	1/4-19
9030-06	3/8-19
9030-08	1/2-14
9030-10	5/8-14
9030-12	3/4-14
9030-16	1-11
9030-20	1-1/4-11
9030-24	1-1/2-11

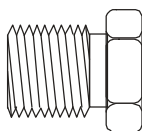

9015 ...MALE BSPP X FEMALE BSPP SWIVEL

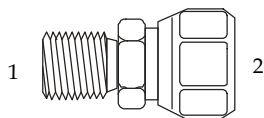

	Male BSPP	Female BSPP
(1) (2)	1/4-19	1/4-19
9015-04-04	1/4-19	1/4-19
9015-04-06	3/8-19	3/8-19
9015-06-06	1/2-14	1/2-14
9015-08-08	5/8-14	5/8-14
9015-10-10	3/4-14	3/4-14
9015-12-12	1-11	1-11
9015-16-16	1-1/4-11	1-1/4-11
9015-20-20	1-1/2-11	1-1/2-11

9000 ...BSPP MALE UNION

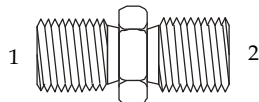

	Male BSPP	Male BSPP
(1) (2)	1/4-19	1/8-28
9000-04-02	1/4-19	1/4-19
9000-04-04	3/8-19	1/4-19
9000-06-04	3/8-19	3/8-19
9000-06-06	1/2-14	1/4-19
9000-08-04	1/2-14	3/8-19
9000-08-06	1/2-14	1/2-14
9000-08-08	5/8-14	5/8-14
9000-10-10	3/4-14	1/2-14
9000-12-08	3/4-14	3/4-14
9000-12-12	1-11	1-11
9000-16-12	1-1/4-11	1-1/4-11
9000-16-16	1-1/2-11	1-1/2-11

9060 ...BSPP 90° ELBOW

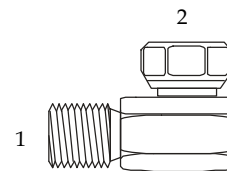

(1) (2)	Male BSPP	Female BSPP
9060-04-04	1/4-19	1/4-19
9060-06-06	3/8-19	3/8-19
9060-08-08	1/2-14	1/2-14
9060-10-10	5/8-14	5/8-14
9060-12-12	3/4-14	3/4-14
9060-16-16	1-11	1-11
9060-20-20	1-1/4-11	1-1/4-11
9060-24-24	1-1/2-11	1-1/2-11

9007 ...BSPP to PIPE ADAPTER

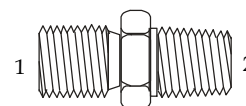

(1) (2)	Male BSPP	Male NPT
9007-04-02	1/4-19	1/8-27
9007-04-04	1/4-19	1/4-18
9007-04-06	1/4-19	3/8-18
9007-04-08	1/4-19	1/2-14
9007-06-04	3/8-19	1/4-18
9007-06-06	3/8-19	3/8-18
9007-06-08	3/8-19	1/2-14
9007-06-12	3/8-19	3/4-14
9007-08-04	1/2-14	1/4-18
9007-08-06	1/2-14	3/8-18
9007-08-08	1/2-14	1/2-14
9007-08-12	1/2-14	3/4-14
9007-10-08	5/8-14	1/2-14
9007-10-12	5/8-14	3/4-14
9007-12-04	3/4-14	1/4-18
9007-12-06	3/4-14	3/8-18
9007-12-08	3/4-14	1/2-14
9007-12-12	3/4-14	3/4-14
9007-12-16	3/4-14	1-11
9007-16-12	1-11	3/4-14
9007-16-16	1-11	1-11-1/2
9007-20-20	1-1/4-11	1-1/4-11-1/2

BSPP ADAPTERS

9240 ...JIC to BSPP SWIVEL

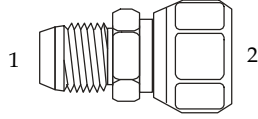

(1) (2)	Male JIC	FEMALE BSPP
9240-04-02	7/16-20	1/8-28
9240-04-04	7/16-20	1/4-19
9240-04-06	7/16-20	3/8-19
9240-06-04	9/16-18	1/4-19
9240-06-06	9/16-18	3/8-19
9240-06-08	9/16-18	1/2-14
9240-08-06	3/4-16	3/8-19
9240-08-08	3/4-16	1/2-14
9240-08-10	3/4-16	5/8-14
9240-08-12	3/4-16	3/4-14
9240-10-10	7/8-14	5/8-14
9240-12-12	1-1/16-12	7/8-14
9240-16-16	1-5/16-12	1-11
9240-20-20	1-5/8-12	1-1/4-11

9002.... JIC to BSPP MALE

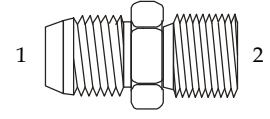

(1) (2)	JIC Male	BSPP Male
9002-04-02	7/16-20	1/8-28
9002-04-04	7/16-20	1/4-19
9002-04-06	7/16-20	3/8-19
9002-05-04	1/2-20	1/4-19
9002-05-06	1/2-20	3/8-19
9002-06-02	9/16-18	1/8-28
9002-06-04	9/16-18	1/4-19
9002-06-06	9/16-18	3/8-19
9002-06-08	9/16-18	1/2-14
9002-06-10	9/16-18	5/8-14
9002-06-12	9/16-18	3/4-14
9002-08-04	3/4-16	1/4-19
9002-08-06	3/4-16	3/8-19
9002-08-08	3/4-16	1/2-14
9002-08-10	3/4-16	5/8-14
9002-08-12	3/4-16	3/4-14
9002-08-16	3/4-16	1-11
9002-10-06	7/8-14	3/8-19
9002-10-08	7/8-14	1/2-14
9002-10-10	7/8-14	5/8-14
9002-10-12	7/8-14	3/4-14
9002-12-08	1-1/16-12	1/2-14
9002-12-10	1-1/16-12	5/8-14
9002-12-12	1-1/16-12	3/4-14
9002-12-16	1-1/16-12	1-11
9002-16-12	1-5/16-12	3/4-14
9002-16-16	1-5/16-12	1-1
9002-16-20	1-5/16-12	1-1/4-11
9002-20-20	1-5/8-12	1-1/4-11
9002-20-24	1-5/8-12	1-1/2-11
9002-24-24	1-7/8-12	1-1/2-11

9035 ...BSPP to FEMALE PIPE

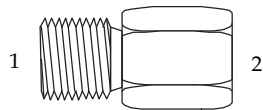

(1) (2)	Male BSPP	Female NPT
9035-02-02	1/8-28	1/8-27
9035-04-04	1/4-19	1/4-18
9035-04-06	3/8-19	3/8-18
9035-06-04	1/4-19	1/4-18
9035-06-06	3/8-19	3/8-18
9035-06-08	1/2-14	1/2-14
9035-08-06	3/8-19	3/8-18
9035-08-08	1/2-14	1/2-14
9035-12-08	5/8-14	1/2-14
9035-12-12	3/4-14	3/4-14
9035-16-16	5/8-14	1-11-1/2
9035-20-20	7/8-14	1-1/4-11-1/2
9035-24-24	1-11	1-1/2-11-1/2

BSPP THREADS

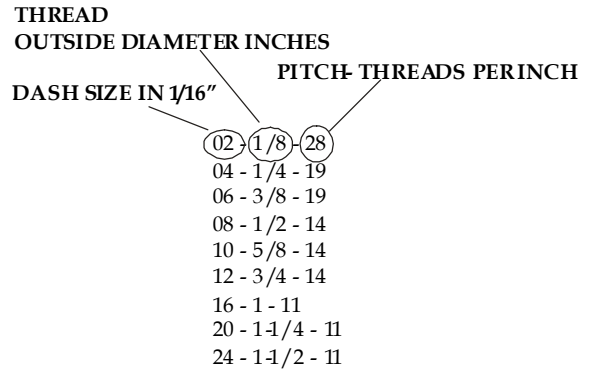

BSPP ADAPTERS

9059... JIC to BSPP 90° ELBOW

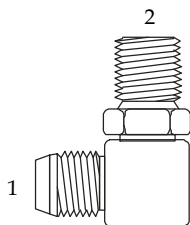

(1) (2)	Male JIC	BSPP Male
9059-04-02	7/16-20	1/8-28
9059-04-04	7/16-20	1/4-19
9059-04-06	7/16-20	3/8-19
9059-06-04	9/16-18	1/4-19
9059-06-06	9/16-18	3/8-19
9059-06-08	9/16-18	1/2-14
9059-08-04	3/4-16	1/4-19
9059-08-06	3/4-16	3/8-19
9059-08-08	3/4-16	1/2-14
9059-08-12	3/4-16	3/4-14
9059-10-06	7/8-14	3/8-19
9059-10-08	7/8-14	1/2-14
9059-12-08	1-1/16-12	1/2-14
9059-12-12	1-1/16-12	3/4-14
9059-16-16	1-5/16-12	1-11
9059-16-20	1-5/16-12	1-1/4-11
9059-20-20	1-5/8-12	1-1/4-11

9021 ...BSPP to JIC SWIVEL ADAPTER

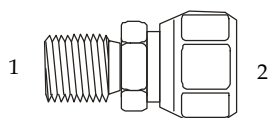

(1) (2)	BSPP Male	Female JIC
9021-04-04	1/4-19	7/16-20
9021-04-06	1/4-19	9/16-18
9021-06-04	3/8-19	7/16-20
9021-06-06	3/8-19	9/16-18
9021-06-08	3/8-19	3/4-16
9021-08-04	1/2-14	7/16-20
9021-08-06	1/2-14	9/16-18
9021-08-08	1/2-14	3/4-16
9021-08-12	1/2-14	1-1/16-12
9021-10-08	5/8-14	3/4-16
9021-12-12	3/4-14	1-1/16-12
9021-16-16	1-11	1-5/16-12

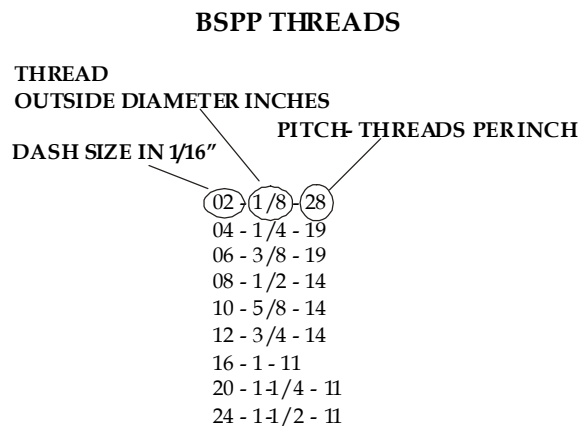

METRIC ADAPTERS

9030M ...METRIC PLUG

9030-M08 x 1.0
 9030-M10 x 1.0
 9030-M10 x 1.5
 9030-M12 x 1.0
 9030-M12 x 1.5
 9030-M14 x 1.5
 9030-M16 x 1.5
 9030-M18 x 1.5
 9030-M20 x 1.5
 9030-M22 x 1.5
 9030-M24 x 1.5
 9030-M26 x 1.5
 9030-M30 x 1.5

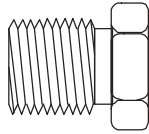

9022 ... JIC to METRIC SWIVEL

(1) (2)
 9022-04-L06-12
 9022-04-L08-14
 9022-05-L06-12
 9022-06-L08-14
 9022-06-L10-16
 9022-06-L12-18
 9022-06-L15-22
 9022-06-S12-20
 9022-08-L10-16
 9022-08-L12-18
 9022-08-L15-22
 9022-08-S12-20
 9022-10-L12-18
 9022-10-L15-22
 9022-10-S12-20

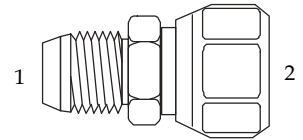

9029 ...HOLLOW HEX METRIC PLUG

9029-08 x 1.0
 9029-10 x 1.0
 9029-12 x 1.5
 9029-14 x 1.5
 9029-16 x 1.5
 9029-18 x 1.5
 9029-20 x 1.5
 9029-22 x 1.5
 9029-24 x 1.5
 9029-26 x 1.5
 9029-27 X 2.0
 9029-33 X 2.0

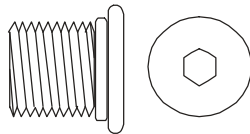

9068 ... JIC to MALE METRIC PORT

(1) (2)
 9068-04-12
 9068-04-14
 9068-06-12
 9068-06-14
 9068-06-16
 9068-06-18
 9068-06-20
 9068-06-22
 9068-08-12
 9068-08-14
 9068-08-16
 9068-08-18
 9068-08-20
 9068-08-22
 9068-10-16
 9068-10-18
 9068-10-20
 9068-10-22
 9068-10-26
 9068-12-26

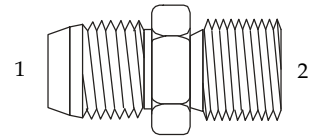

9235 ...METRIC to FEMALE PIPE

(1) (2)
 9235-10-02
 9235-12-04
 9235-14-04
 9235-16-06
 9235-16-08
 9235-18-08
 9235-20-08
 9235-22-06
 9235-22-08
 9235-26-08
 9235-26-12

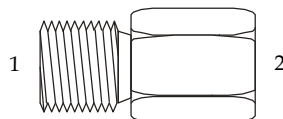

9069 ... JIC to METRIC 90°

(1) (2)
 9069-04-10
 9069-04-12
 9069-04-14
 9069-05-12
 9069-05-14
 9069-06-12
 9069-06-14
 9069-06-16
 9069-06-18
 9069-08-16
 9069-08-18
 9069-08-20
 9069-08-22
 9069-10-18
 9069-10-20
 9069-10-22
 9069-12-22
 9069-12-26
 9069-12-27
 9069-16-27
 9069-16-33

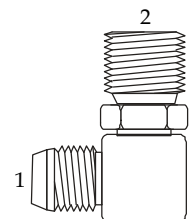

9200 ...JIC X METRIC STANDPIPE

(1) (2)
 9200-04-06
 9200-04-08
 9200-04-10
 9200-06-10
 9200-08-10
 9200-06-12
 9200-08-12
 9200-06-14
 9200-08-15
 9200-12-25

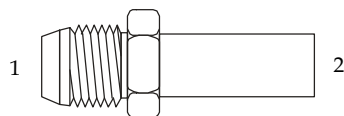

METRIC & JAPANESE ADAPTERS

9201L ...METRIC TUBE NUT (LIGHT) DIN 2353 L

9201L-06
9201L-08
9201L-10
9201L-12
9201L-15
9201L-18
9201L-22
9201L-28
9201L-35
9201L-42

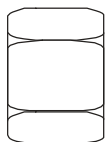

9231 ...JAPANESE KOMATSU METRIC PLUG

9231-14 KOMATSU HEX PLUG
9231-16 KOMATSU = 30° SEAT, 1.5mm PITCH,
9231-18 METRIC THREAD
9231-22
9231-24
9231-30
9231-33
9231-36
9231-42

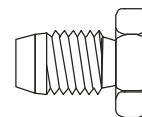

9202 ...METRIC TUBE CUTTING RING - DIN 2353 S/L

9202-06
9202-08
9202-10
9202-12
9202-14
9202-15
9202-16
9202-18
9202-20
9202-22
9202-25
9202-28
9202-30
9202-35
9202-38
9202-42

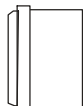

9236 ...MALE KOMATSU UNION

9236-14-14 MALE KOMATSU X MALE KOMATSU
9236-18-18 KOMATSU = 30° SEAT, 1.5mm PITCH,
9236-22-22 METRIC THREAD
9236-24-24
9236-30-30
9236-33-33

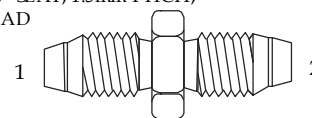

9237 ...MALE JIC x JAPANESE KOMATSU

(1) (2) MALE JIC X MALE KOMATSU
9237-04-14 KOMATSU = 30° SEAT, 1.5mm PITCH,
9237-06-16 METRIC THREAD
9237-06-18
9237-08-22
9237-10-24
9237-12-30
9237-16-33

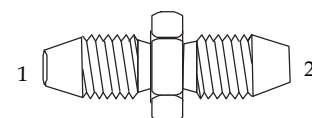

9201S ...METRIC TUBE NUT (HEAVY) DIN 2353 S

9201S-06
9201S-08
9201S-10
9201S-12
9201S-14
9201S-16
9201S-20
9201S-25
9201S-30
9201S-38

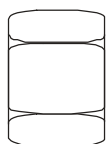

9222 ...JAPANESE 30° FLARE CAP

9222-02 JIS CAP (SOLID)
9222-04 JIS = 30° SEAT, BSPP THREAD
9222-06
9222-08
9222-10
9222-12
9222-16
9222-20
9222-24
9222-32

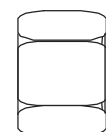

9232 ...JAPANESE KOMATSU CAP

9232-14 KOMATSU CAP (SOLID)
9232-16 KOMATSU = 30° SEAT, 1.5mm PITCH,
9232-18 METRIC THREAD
9232-22
9232-24
9232-30
9232-33
9232-42

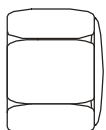

9221 ...JAPANESE 30° FLARE PLUG

9221-02 JIS HEX PLUG
9221-04 JIS = 30° SEAT, BSPP THREAD
9221-06
9221-08
9221-12
9221-16
9221-20
9221-24
9221-32

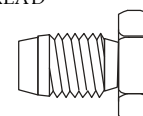

LIVE SWIVEL JOINTS

...MALE JIC TO FEMALE JIC

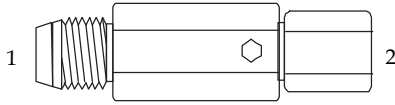

(1) (2)	Male JIC	Female JIC
S6-J6-JF6	9/16-18	9/16-18
S6-J8-JF8	3/4-16	3/4-16
S8-J10-JF10	7/8-14	7/8-14
S8-J12-JF12	1-1/16-12	1-1/16-12
S16-J16-JF16	1-5/16-12	1-5/16-12
S20-J20-JF20	1-5/8 -12	1-5/8 -12
S24-J24-JF24	1-7/8 -12	1-7/8 -12
S32-J32-JF32	2-1/2 -12	2-1/2 -12

...FEMALE PIPE UNION TO O-RING

(1) (2)
 9S6PU4O6
 9S6PU6O6
 9S6PU6O8
 9S8PU8O10
 9S12PU12O12
 9S16PU16O16
 9S20PU20O20
 9S24PU24O24
 9S32PU32O32

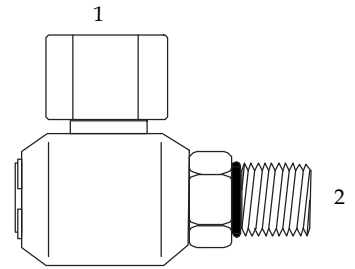

...FEMALE PIPE TO FEMALE PIPE

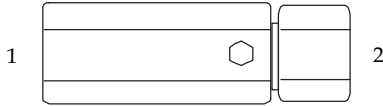

(1) (2)	FNPT	FNPT
S6PF4PF4	1/4 - 18	1/4 - 18
S6PF6PF6	3/8 - 18	3/8 - 18
S8PF8PF8	1/2 - 14	1/2 - 14
S8PF12PF12	3/4 - 14	3/4 - 14
S16PF16PF16	1 - 11-1/2	1 - 11-1/2
S20PF20PF20	1-1/4 - 11-1/2	1-1/4 - 11-1/2
S24PF24PF24	1-1/2 - 11-1/2	1-1/2 - 11-1/2
S32PF32PF32	2 - 11-1/2	2 - 11-1/2

...FEMALE PIPE UNION TO MALE PIPE

(1) (2)
 9S6PU4P4
 9S6PU4P6
 9S6PU6P4
 9S6PU6P6
 9S8PU8P8
 9S12PU12P12
 9S16PU16P16
 9S20PU20P20

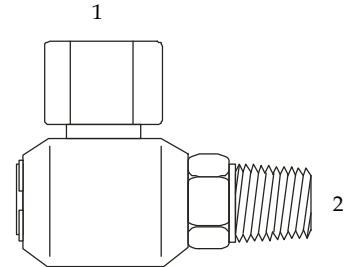

...MALE JIC TO FEMALE PIPE

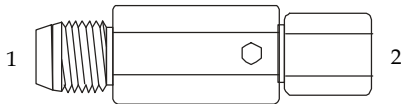

(1) (2)	Male JIC	FNPT
S6J6PF4	9/16-18	1/4 - 18
S6J8PF6	3/4-16	3/8 - 18
S8J10PF8	7/8-14	1/2 - 14
S8J12PF12	1-1/16-12	3/4 - 14
S16J16PF16	1-5/16-12	1 - 11-1/2
S20J20PF20	1-5/8 -12	1-1/4 - 11-1/2
S24J24PF24	1-7/8 -12	1-1/2 - 11-1/2
S32J32PF32	2-1/2 -12	2 - 11-1/2

...FEMALE PIPE UNION TO FEMALE PIPE

(1) (2)
 9S6PU4PF4
 9S6PU4PF6
 9S6PU6PF4
 9S6PU6PF6
 9S8PU8PF8
 9S12PU12PF12
 9S16PU16PF16

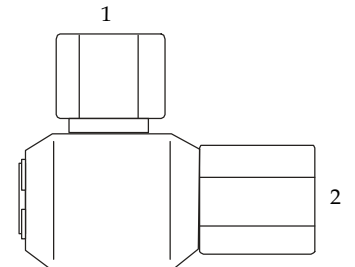

...FEMALE PIPE TO MALE PIPE

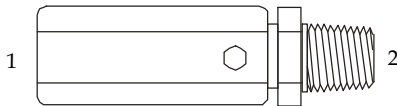

(1) (2)	FNPT	MNPT
S6PF4P4	1/4 - 18	1/4 - 18
S6PF6P6	3/8 - 18	3/8 - 18
S8PF8P8	1/2 - 14	1/2 - 14
S8PF12P12	3/4 - 14	3/4 - 14
S16PF16P16	1 - 11-1/2	1 - 11-1/2
S20PF20P20	1-1/4 - 11-1/2	1-1/4 - 11-1/2
S24PF24P24	1-1/2 - 11-1/2	1-1/2 - 11-1/2
S32PF32P32	2 - 11-1/2	2 - 11-1/2

...FEMALE PIPE TO FEMALE PIPE

(1) (2)
 9S6PF4PF4
 9S6PF4PF6
 9S6PF6PF4
 9S6PF6PF6
 9S8PF8PF8
 9S12PF12PF12
 9S16PF16PF16
 9S20PF20PF20
 9S24PF24PF24
 9S32PF32PF32

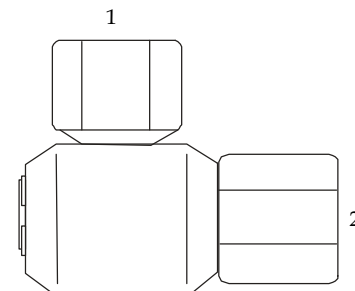

LIVE SWIVEL JOINTS

...MALE JIC TO MALE O-RING

(1)(2)
 9S6J6O6
 9S6J6O8
 9S6J8O8
 S8J12O12
 9S12J12O12
 9S16J16O16
 9S20J20O20

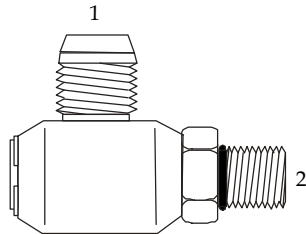

...MALE PIPE TO MALE O-RING

(1)(2)
 9S6P4O5
 9S6P4O6
 9S6P6O5
 9S6P6O6
 9S6P6O8
 9S8P8O10
 9S12P12O12
 9S16P16O16
 9S20P20O20
 9S24P24O24
 9S32P32O32

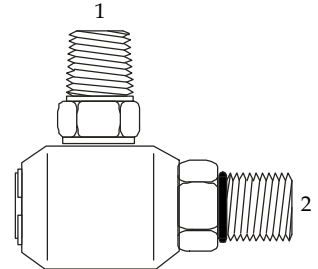

...MALE JIC TO MALE JIC

(1)(2)
 9S6J5J5
 9S6J5J6
 9S6J6J5
 9S6J6J6
 9S6J6J8
 9S6J8J8
 9S8J10J10
 9S12J12J12
 9S16J16J16
 9S20J20J20

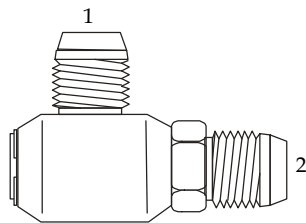

...MALE PIPE TO MALE PIPE

(1)(2)
 9S6P4P4
 9S6P4P6
 9S6P6P4
 9S6P6P6
 9S8P8P8
 9S12P12P12
 9S16P16P16
 9S20P20P20

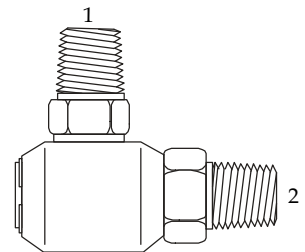

...MALE JIC TO MALE PIPE

(1)(2)
 9S6J6P6
 9S6J8P6
 9S8J10P8
 9S8J8P8
 9S6J5P4
 9S6J5P6
 9S6J6P4
 9S12J12P12
 9S16J16P16
 9S20J20P20

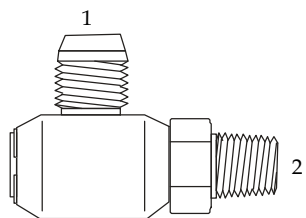

...MALE PIPE TO FEMALE PIPE

(1)(2)
 9S6P4PF4
 9S6P4PF6
 9S6P6PF4
 9S6P6PF6
 9S8P8PF8
 9S12P12PF12
 9S20P20PF20
 9S24P24PF24

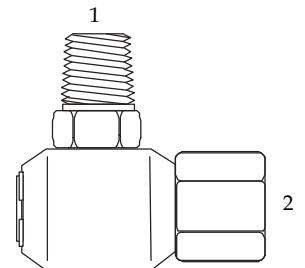

...MALE JIC TO FEMALE PIPE

(1)(2)
 9S6J5PF4
 9S6J5PF6
 9S6J6PF4
 9S6J6PF6
 9S6J8PF6
 9S8J10PF8
 9S8J8PF8
 9S12J12PF12
 9S16J16PF16
 9S20J20PF20

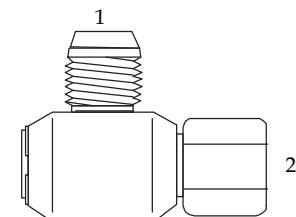

S ...STRAIGHT SWIVEL REPAIR KIT

S6-1
 S8-1
 S12-1
 S16-1
 S20-1
 S24-1
 S32-1
Kit contains Dust and Fluid Seals with Retaining Rings, Balls, and Plugs as Applicable.

9S ...90° SWIVEL REPAIR KIT

9S6-1
 9S8-1
 9S12-1
 9S16-1
 9S20-1
 9S24-1
 9S32-1
Kit contains Dust and Fluid Seals with Retaining Rings, Balls, and Plugs as Applicable.

SAE FLANGE ADAPTERS

6100 ...SAE CODE 61 FLANGE MALE JIC ADAPTER

- (1) (2)
- 6100-08-08
- 6100-08-12
- 6100-12-12
- 6100-12-16
- 6100-12-20
- 6100-16-12
- 6100-16-16
- 6100-16-10
- 6100-16-14
- 6100-20-16
- 6100-20-20
- 6100-20-24
- 6100-20-32
- 6100-24-20
- 6100-24-24
- 6100-24-32
- 6100-32-24
- 6100-32-32

"Some sizes available in Forged or Tube Style"

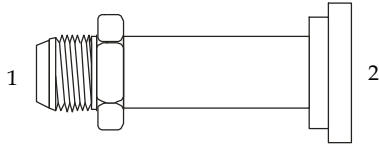

(1) Male Tube (2) C 61 Flange

6145 ...SAE CODE 61 FLANGE MALE JIC 45° ELBOW

- (1) (2)
- 6145-08-08
- 6145-08-12
- 6145-12-12
- 6145-12-16
- 6145-16-16
- 6145-16-20
- 6145-12-20
- 6145-16-20
- 6145-20-20
- 6145-16-24
- 6145-20-24
- 6145-24-24
- 6145-24-32
- 6145-32-32

"Some sizes available in Forged or Tube Style"

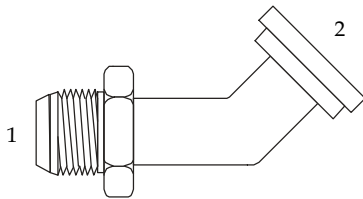

(1) Male Tube (2) C 61 Flange

6190 ...SAE C61 FLANGE MALE- JIC 90° ELBOW

- (1) (2)
- 6190-08-08
- 6190-12-12
- 6190-12-16
- 6190-12-20
- 6190-16-12
- 6190-16-16
- 6190-16-20
- 6190-16-24
- 6190-20-12
- 6190-20-16
- 6190-20-20
- 6190-20-24
- 6190-24-16
- 6190-24-20
- 6190-24-24
- 6190-24-32
- 6190-32-24
- 6190-32-32

"Some sizes available in Forged or Tube Style"

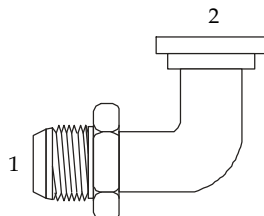

(1) Male Tube (2) C 61 Flange

SFO ...SAE CODE 61 FLANGE KIT (3000 PSI)

- SFO-08
- SFO-12
- SFO-16
- SFO-20
- SFO-24
- SFO-32
- SFO-48
- SFO-56
- SFO-64

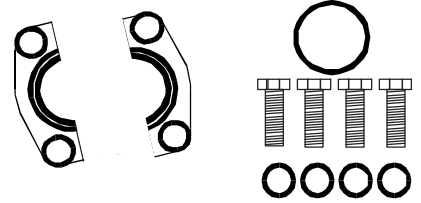

FP ...SAE CODE 61 FLANGE PLUG

- FP-08
- FP-12
- FP-16
- FP-20
- FP-24
- FP-32



W43 ...SAE CODE 61 FLANGE KIT (3000 PSI)

- W43-08-08U
- W43-12-12U
- W43-16-16U
- W43-20-20U
- W43-24-24U
- W43-32-32U
- W43-48-48U

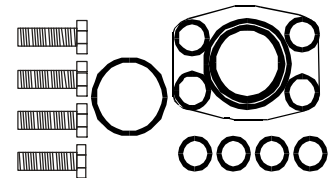

FLANGE SIZE	CODE 61 FLANGE DIA.	CODE 62 FLANGE DIA.
08 - 1/2"	08 - 1.188"	12 - 1.625"
12 - 3/4"	12 - 1.500"	16 - 1.875"
16 - 1"	16 - 1.750"	20 - 2.125"
20 - 1-1/4"	20 - 2.000"	24 - 2.500"
24 - 1-1/2"	24 - 2.375"	32 - 3.125"
32 - 2"	32 - 2.810"	
40 - 2-1/2"	40 - 3.312"	
48 - 3"	48 - 4.000"	

SAE FLANGE O-RINGS

FLANGE SIZE	O-RING I.D.	WALL DIA.
PA-08	0.734"	0.139"
PA-12	0.984"	0.139"
PA-16	1.296"	0.139"
PA-20	1.484"	0.139"
PA-24	1.859"	0.139"
PA-32	2.234"	0.139"

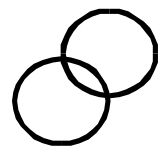

SAE FLANGE ADAPTERS

6200 ...SAE CODE 62 FLANGE - MALE JIC ADAPTER

- (1) (2)
- 6200-08-08
- 6200-08-12
- 6200-12-12
- 6200-12-16
- 6200-12-20
- 6200-16-20
- 6200-16-24
- 6200-20-16
- 6200-20-20
- 6200-20-24
- 6200-20-32
- 6200-24-20
- 6200-24-24
- 6200-24-32
- 6200-32-24
- 6200-32-32

"Some sizes available in Forged or Tube Style"

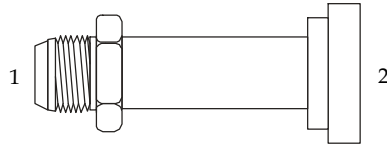

(1) Male Tube (2) C 62 Flange

6245 ...SAE CODE 62 FLANGE - MALE JIC 45°ELBOW

- (1) (2)
- 6245-08-08
- 6245-08-12
- 6245-12-12
- 6245-12-16
- 6245-16-16
- 6245-16-20
- 6245-12-20
- 6245-16-20
- 6245-16-24
- 6245-20-20
- 6245-20-24
- 6245-24-24
- 6245-24-32
- 6245-32-32

"Some sizes available in Forged or Tube Style"

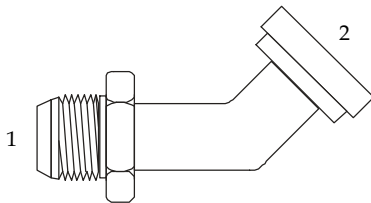

(1) Male Tube (2) C 62 Flange

6290 ...SAE CODE 62 FLANGE MALE JIC 90°ELBOW

- (1) (2)
- 6290-08-08
- 6290-12-12
- 6290-12-16
- 6290-12-20
- 6290-16-16
- 6290-16-20
- 6290-16-24
- 6290-20-12
- 6290-20-16
- 6290-20-20
- 6290-20-24
- 6290-24-16
- 6290-24-20
- 6290-24-24
- 6290-24-32
- 6290-32-24
- 6290-32-32

"Some sizes available in Forged or Tube Style"

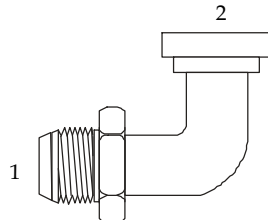

(1) Male Tube (2) C 62 Flange

SFXO ...SAE CODE 62 FLANGE KIT (6000 PSI)

- SFXO-08
- SFXO-12
- SFXO-16
- SFXO-20
- SFXO-24
- SFXO-32
- SFXO-48
- SFXO-56
- SFXO-64

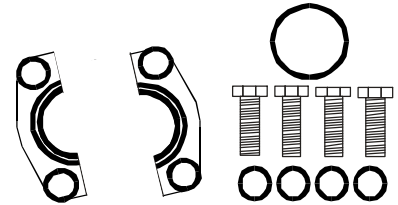

FPX ...SAE CODE 62 FLANGE PLUG

- FPX-08
- FPX-12
- FPX-16
- FPX-20
- FPX-24
- FPX-32



W44 ...SAE CODE 62 FLANGE KIT (6000 PSI)

- W43-08-08U
- W43-12-12U
- W43-16-16U
- W43-20-20U
- W43-24-24U
- W43-32-32U
- W43-48-48U

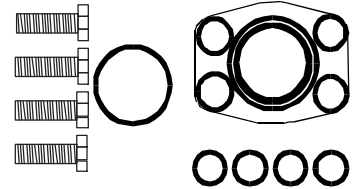

FLANGE SIZE	CODE 61 FLANGE DIA.	CODE 62 FLANGE DIA.
08 - 1/2"	08 - 1.188"	
12 - 3/4"	12 - 1.500"	12 - 1.625"
16 - 1"	16 - 1.750"	16 - 1.875"
20 - 1-1/4"	20 - 2.000"	20 - 2.125"
24 - 1-1/2"	24 - 2.375"	24 - 2.500"
32 - 2"	32 - 2.810"	32 - 3.125"
40 - 2-1/2"	40 - 3.312"	
48 - 3"	48 - 4.000"	

SAE FLANGE O-RINGS

FLANGE SIZE	O-RING ID.	WALL DIA.
PA-08	0.734"	0.139"
PA-12	0.984"	0.139"
PA-16	1.296"	0.139"
PA-20	1.484"	0.139"
PA-24	1.859"	0.139"
PA-32	2.234"	0.139"

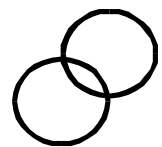

BLACK PIPE FLANGE

O-RINGS

1600 ... HOSE BARB X C61 FLANGE

- (1) (2)
- 1600-20-20
- 1600-20-24
- 1600-24-20
- 1600-24-24
- 1600-24-32
- 1600-32-24
- 1600-32-32
- 1600-32-40
- 1600-40-32
- 1600-40-40
- 1600-40-48
- 1600-48-40

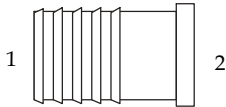

1600 ... HOSE BARB X C61 FLANGE 45° ELBOW

- (1) (2)
- 1645-20-20
- 1645-20-24
- 1645-24-20
- 1645-24-24
- 1645-24-32
- 1645-32-24
- 1645-32-32
- 1645-32-40
- 1645-40-32
- 1645-40-40
- 1645-40-48
- 1645-48-40

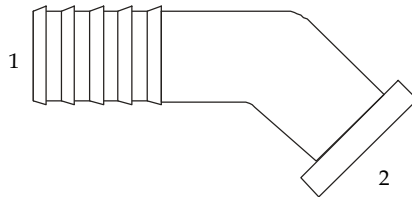

1600 ... HOSE BARB X C61 FLANGE 90° ELBOW

- (1) (2)
- 1690-20-20
- 1690-20-24
- 1690-24-20
- 1690-24-24
- 1690-24-32
- 1690-32-24
- 1690-32-32
- 1690-32-40
- 1690-40-32
- 1690-40-40
- 1690-40-48
- 1690-48-40
- 1690-48-48
- 1690-64-64

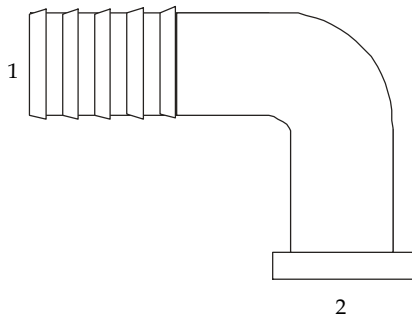

FLANGE SIZE	CODE 61 FLANGE DIAMETER
08 - 1/2"	08 - 1.188"
12 - 3/4"	12 - 1.500"
16 - 1"	16 - 1.750"
20 - 1-1/4"	20 - 2.000"
24 - 1-1/2"	24 - 2.375"
32 - 2"	32 - 2.810"
40 - 2-1/2"	40 - 3.312"
48 - 3"	48 - 4.000"

SAE FLANGE O-RINGS

FLANGE SIZE	O-RING I.D.	WALL DIA.
PA-08	0.734"	0.139"
PA-12	0.984"	0.139"
PA-16	1.296"	0.139"
PA-20	1.484"	0.139"
PA-24	1.859"	0.139"
PA-32	2.234"	0.139"

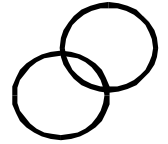

ORB ... O-RING BOSS (ORB) O-RINGS

	O-RING I.D.	O-RING I.D.
ORB-2	.239"	ORB-12 .924"
ORB-3	.301"	ORB-14 .1.048"
ORB-4	.351"	ORB-16 .1.171"
ORB-5	.414"	ORB-20 .1.475"
ORB-6	.468"	ORB-24 .1.720"
ORB-8	.644"	ORB-32 .2.337"
ORB-10	.755"	

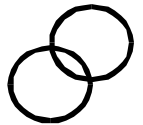

ORS ... O-RING FACE SEAL (ORFS) O-RINGS

	O-RING I.D.	WALL I.D.
ORS-04	.301"	0.70
ORS-06	.364"	0.70
ORS-08	.489"	0.70
ORS-10	.614"	0.70
ORS-12	.739"	0.70
ORS-16	.926"	0.70
ORS-20	1.176"	0.70
ORS-24	1.489"	0.70



9500 ... BSPP BONDED SEALS

	BSPP THREAD
9500-02	1/8 - 27
9500-04	1/4 - 19
9500-06	3/8 - 19
9500-08	1/2 - 14
9500-10	5/8 - 14
9500-12	3/4 - 14
9500-16	1 - 11
9500-20	1-1/4 - 11
9500-24	1-1/2 - 11
9500-32	2 - 11

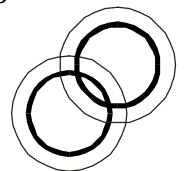

9500M ... METRIC BONDED SEALS

	METRIC THREAD
9500M-06	06mm
9500M-08	08mm
9500M-10	10mm
9500M-12	12mm
9500M-14	14mm
9500M-16	16mm
9500M-18	18mm
9500M-20	20mm
9500M-22	22mm
9500M-24	24mm
9500M-26	26mm
9500M-30	30mm
9500M-33	33mm

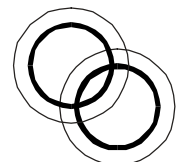

Hydraulic Hose & Fittings



Stirling Hydraulic

**6807-68 Ave.
Edmonton, AB.
T6B 3E3**

**Ph: 780-450-6111
Fax: 780-450-8887
Email: sales@stirlinghydraulic.com**

Web Site: www.stirlinghydraulic.com